

Meade

Distributing

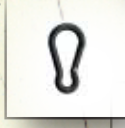
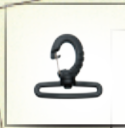
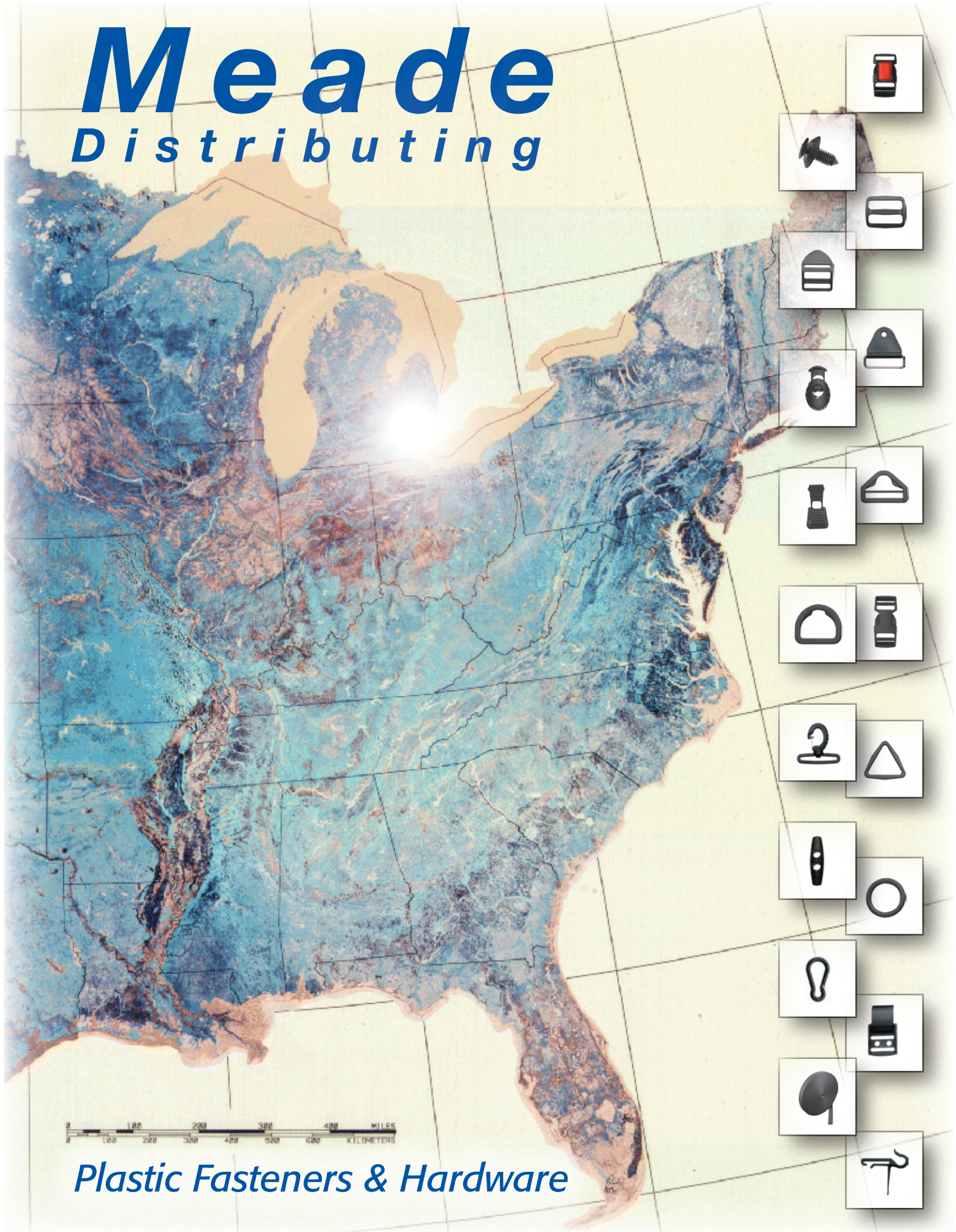

0 100 200 300 400 MILES
0 100 200 300 400 500 600 KILOMETERS

Plastic Fasteners & Hardware

CONTENTS

SINGLE SIDE RELEASE BUCKLES	1-3
DUAL SIDE RELEASE BUCKLES	3
CENTER RELEASE BUCKLES	4
CAM BUCKLES	5
SAFETY BUCKLES	6-7
SPECIALTY SIDE RELEASE BUCKLES	8-9
LADDER LOCKS	10-12
3-BAR SLIDES	13-15
6 ANGLE DOUBLE BAR RINGS	16
STRAP DIVIDERS	17
GALLUSES	17-18
SQUARE LOOPS	19-20
BELT LOOPS	21
SPECIALTY LOOPS	22
D-RINGS	23-24
TRI-RINGS	25
O-RINGS	25
CLIPS • HOOKS	26-27
SNAP / CARABINER / HANG HOOKS	28-33
SHOULDER PADS	34-36
ZIPPER PULLS	37
CORD LOCKS & ENDS • BOTTLE HOLDER	38-39
STAYPUT FASTENERS	40
PLASTIC TURN FASTENERS	40
PLASTIC GROMMETS	41
PLASTIC SNAP FASTENERS	41
PANEL FASTENERS	42-44
HOOK & LOOP	44-47
WEBBING	48-49

SINGLE SIDE RELEASE BUCKLES

Side release buckles offer quick release action along with webbing grip and adjustment. Many styles are available to enhance both appearance and function for numerous applications.

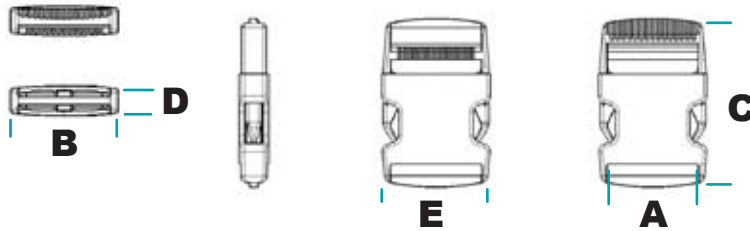

WEBBING DIAGRAM

CLASSIC

MATERIAL • POLYACETAL

IN.	MM	PART #	A	B	C	D	E
5/8	16	BK 202-16	16.50	20.80	42.70	8.00	16.80
3/4	20	BK 202-20	19.46	24.72	52.43	9.78	19.92
1	25	BK 202-25	26.36	33.16	62.60	9.45	25.80
1 1/4	32	BK 202-32	32.40	40.25	65.32	12.20	32.60
1 1/2	38	BK 202-38	39.67	46.60	72.31	12.88	39.00
2	51	BK 202-51	52.03	59.20	80.47	14.35	51.60

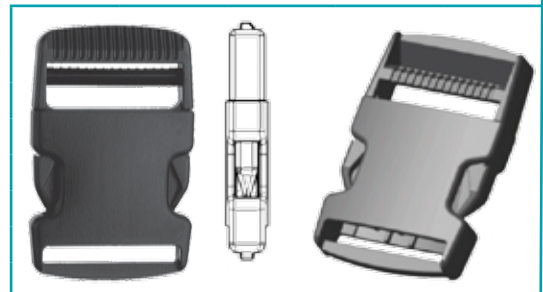

CLASSIC • CAMBER

MATERIAL • POLYACETAL

IN.	MM	PART #	A	B	C	D	E
3/4	20	BK 221-20	20.30	25.89	52.68	11.10	20.46
1	25	BK 221-25	26.40	32.20	62.54	12.83	26.00
1 1/2	38	BK 221-38	39.20	45.85	71.22	15.26	39.00
2	51	BK 221-51	52.00	58.54	80.49	16.61	51.70



CLASSIC • CONTOUR

MATERIAL • POLYACETAL

IN.	MM	PART #	A	B	C	D
3/8	10	BK 208-10	11.00	15.54	33.90	8.39
3/8	10	BK 208-3-10	11.00	15.54	28.70	7.71
1/2	13	BK 208-13	13.00	17.41	43.50	12.32
5/8	16	BK 208-16	16.50	21.00	45.00	12.00
3/4	20	BK 208-20	19.60	25.00	52.50	12.46
1	25	BK 208-25	26.00	31.60	67.50	15.41
2	51	BK 207-51				



HEAVY DUTY • CONTOUR

MATERIAL • POLYACETAL

IN.	MM	PART #	A	B	C	D	E
5/8	16	BK 208-1-16	16.50	21.00	45.00	12.00	16.60
3/4	20	BK 208-1-20	19.60	25.00	52.50	12.46	19.60
1	25	BK 208-1-25	26.00	31.60	67.50	15.41	26.20
1 1/8	29	BK 208-1-29	29.00	41.35	63.70	17.03	28.90



EURO STYLE • CLASSIC

MATERIAL • POLYACETAL

IN.	MM	PART #	A	B	C	D	E
			METRIC	METRIC	METRIC	METRIC	METRIC
3/4	20	BK 223-20	19.80	25.22	49.71	9.30	19.70
1	25	BK 223-25	25.70	33.20	64.32	11.79	25.90
1 1/4	32	BK 223-32	32.40	39.98	66.74	12.70	31.70
1 1/2	38	BK 223-38	38.75	46.40	71.00	14.00	38.56
2	51	BK 223-51	52.10	62.26	80.00	15.50	51.60

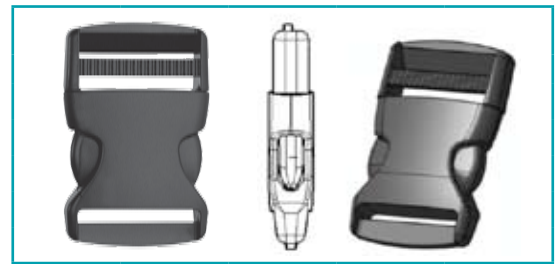

EURO STYLE • CLASSIC • HIGH STRENGTH

MATERIAL • POLYACETAL

IN.	MM	PART #	A	B	C	D
			METRIC	METRIC	METRIC	METRIC
1	25	BK 229-25	26.86	33.31	70.21	12.71



EURO STYLE • CAMBER

MATERIAL • POLYACETAL

IN.	MM	PART #	A	B	C	D	E
			METRIC	METRIC	METRIC	METRIC	METRIC
3/4	20	BK 227-20	19.70	24.80	51.00	N/A	19.70
1	25	BK 227-25	25.80	33.30	61.70	11.30	25.80
1 1/2	38	BK 227-38	39.10	45.10	67.27	15.88	39.00
2	51	BK 227-51	51.60	59.10	79.20	19.11	51.36



EURO STYLE • WIDE • OVERSIZED • SQUARE

MATERIAL • POLYACETAL

IN.	MM	PART #	A	B	C	D	E
			METRIC	METRIC	METRIC	METRIC	METRIC
3/4	20	BK 206-20	19.90	29.28	52.00	10.00	19.80
1	25	BK 206-25	26.20	36.40	60.80	12.00	25.80
1 1/4	32	BK 206-32	32.20	39.70	65.80	12.40	32.50
1 1/2	38	BK 206-38	39.80	51.50	79.20	17.50	38.80
2	51	BK 206-51	51.70	65.50	79.20	16.00	50.60
2	51	BK 206-1-51	51.70	63.50	84.10	15.00	63.50

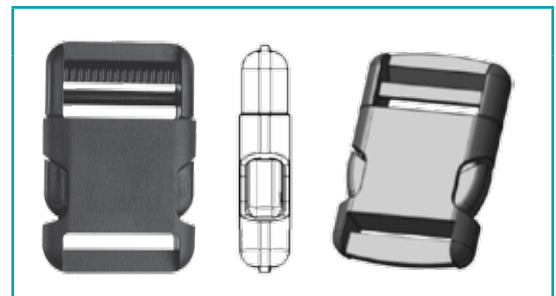

EURO STYLE • TAPERED

MATERIAL • POLYACETAL / NYLON

IN.	MM	PART #	A	B	C	E
			METRIC	METRIC	METRIC	METRIC
1 1/2	38	BK 220-38	39.60	50.00	75.30	39.80
1 1/2	38	BK 220N-38	39.60	50.00	75.30	39.80



EURO STYLE • SLIMLINE

MATERIAL • NYLON

IN.	MM	PART #	A	B	C	D	E
			METRIC	METRIC	METRIC	METRIC	METRIC
1	25	BK 225-25	N/A	N/A	N/A	N/A	N/A
1 1/2	38	BK 225-38	38.69	54.87	80.39	15.14	38.69



HIGH STRENGTH

MATERIAL • POLYACETAL

IN.	MM	PART #	A	B	C	D	E
			METRIC	METRIC	METRIC	METRIC	METRIC
1	25	BK 223-25	26.86	33.31	70.21	12.71	26.86



SOFT TOUCH

MATERIAL • NYLON

IN.	MM	PART #	A	B	C	D
			METRIC	METRIC	METRIC	METRIC
3/4	20	BK 206N-20	19.90	29.28	52.00	10.00
1	25	BK 206N-25	26.20	36.40	60.80	12.00
1	25	BK 206N-1-25	26.20	36.40	60.80	12.00
1 1/4	32	BK 206N-32	32.20	39.70	65.80	12.40
1 1/2	38	BK 206N-38	39.80	51.50	79.20	17.50
2	51	BK 206N-51	51.70	65.50	79.20	16.00



DUAL SIDE RELEASE BUCKLES

A variety of dual side release buckles are available to accommodate a wide range of applications and enhance product appearance and design.

CLASSIC

MATERIAL • POLYACETAL

IN.	MM	PART #	A	B	C	D	E
			METRIC	METRIC	METRIC	METRIC	METRIC
3/4	20	BK 210-20	19.86	24.78	57.59	9.80	20.22
1	25	BK 210-25	25.90	32.80	72.15	10.40	25.80
1 1/4	32	BK 210-32	32.20	40.12	72.94	11.90	32.60
1 1/2	38	BK 210-38	38.80	46.46	80.47	13.10	39.00
2	51	BK 210-51	51.20	59.24	89.95	14.55	51.60



CLASSIC • CAMBER

MATERIAL • POLYACETAL

IN.	MM	PART #	A	B	C	D	E
			METRIC	METRIC	METRIC	METRIC	METRIC
3/4	20	BK 222-20	20.10	25.89	58.54	10.83	20.46
1	25	BK 222-25	26.00	32.03	68.68	13.19	26.20
1 1/2	38	BK 222-38	39.20	45.85	78.05	15.26	39.00
2	51	BK 222-51	51.80	58.54	88.78	16.45	51.70

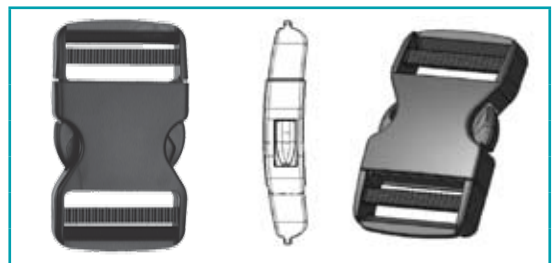

EURO STYLE • CAMBER

MATERIAL • POLYACETAL

IN.	MM	PART #	A	B	C	D	E
			METRIC	METRIC	METRIC	METRIC	METRIC
1 1/2	38	BK 228-38	39.10	45.11	75.20	15.88	39.00
2	51	BK 228-51	51.40	59.10	89.70	19.35	51.36



CENTER RELEASE BUCKLES

A variety of specialty buckles are available to accommodate a wide range of applications and industries. Commonly used in the pet, industrial safety and lanyard industries.

CENTER RELEASE

MATERIAL • POLYACETAL

IN.	MM	PART #	A	B	C	D	E
			METRIC	METRIC	METRIC	METRIC	METRIC
1	25	BK 203-25	27.15	33.90	49.60	6.60	27.50
1 1/4	32	BK 203-32	32.75	40.55	60.85	6.40	32.75
1 1/2	38	BK 203-38	38.85	47.60	66.80	6.85	39.10



CENTER RELEASE

MATERIAL • POLYACETAL

IN.	MM	PART #	A	B	C	D
			METRIC	METRIC	METRIC	METRIC
1	25	BK 219-25	26.30	32.00	50.00	8.68
1 1/2	38	BK 219-38	39.00	46.20	57.20	10.87



CENTER RELEASE

MATERIAL • POLYACETAL

IN.	MM	PART #	A	B	C	D	E
			METRIC	METRIC	METRIC	METRIC	METRIC
3/8	10	BK 211-10	10.70	14.50	25.80	6.80	N/A

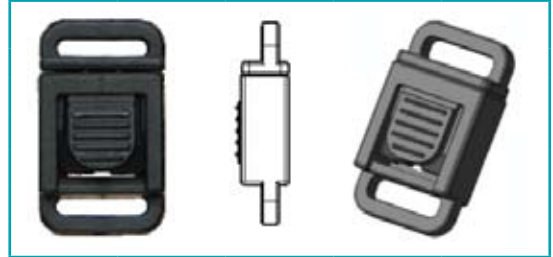

CAM BUCKLES

Cam buckles offer one-handed secure grip adjustment and locking action that prevents unintentional webbing slippage.

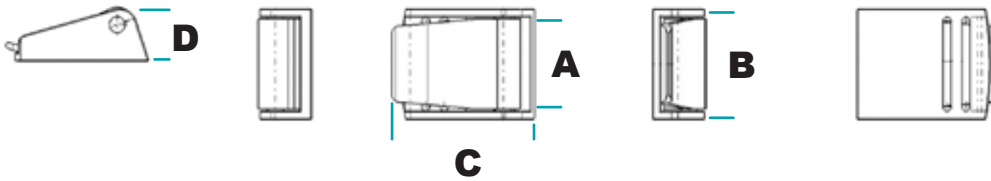

WEBBING DIAGRAM

CLASSIC

MATERIAL • POLYACETAL

IN.	MM	PART #	A	B	C	D
			METRIC	METRIC	METRIC	METRIC
5/8	16	BK 505-16	15.00	20.50	28.23	10.80
3/4	20	BK 505-20	19.40	26.00	30.50	13.20
1	25	BK 505-25	24.50	31.80	36.30	13.90
1 1/4	32	BK 505-32	32.80	39.60	49.79	17.50
1 1/2	38	BK 505-38	39.50	46.50	60.30	22.00
2	51	BK 505-51	54.10	61.70	73.40	22.20

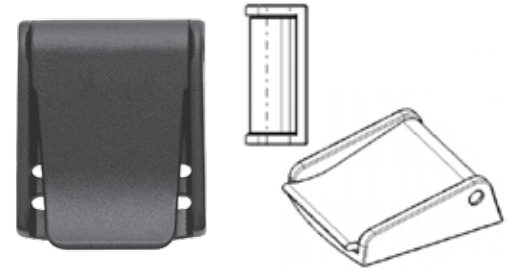

MOUNTABLE

MATERIAL • POLYACETAL

IN.	MM	PART #	A	B	C	D
			METRIC	METRIC	METRIC	METRIC
1	25	BK 505-1-25	25.70	31.70	36.00	14.20



SAFETY BUCKLES

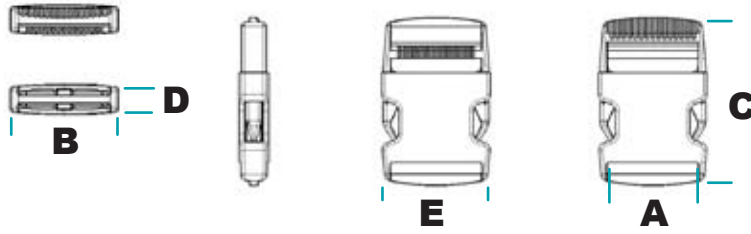

WEBBING DIAGRAM

PET LOCK

MATERIAL • POLYACETAL

IN.	MM	PART #	A	B	C	D	E
			METRIC	METRIC	METRIC	METRIC	METRIC
3/8	10	BK 212-10	10.40	17.80	25.79	5.90	



QUICK RELEASE • ADJUSTABLE

MATERIAL • POLYACETAL

IN.	MM	PART #	A	B	C	D	E
			METRIC	METRIC	METRIC	METRIC	METRIC
1	25	BK 201-25	25.90	36.11	54.25	9.00	25.50
1 1/4	32	BK 201-32	32.30	39.31	65.00	11.00	32.00
1 1/2	38	BK 201-38					



REFLECTOR

MATERIAL • POLYACETAL

IN.	MM	PART #	A	B	C	D	E
			METRIC	METRIC	METRIC	METRIC	METRIC
1	25	BK 205-25	26.36	33.16	62.60	12.40	
1	25	BK 205N-1-25	26.20	36.40	60.80	14.10	



NYLON

BREAKAWAY • CONTOUR

MATERIAL • POLYACETAL

IN.	MM	PART #	A	B	C	D	E
			METRIC	METRIC	METRIC	METRIC	METRIC
3/8	10	BK 208-2-10	11.00	15.54	28.70	7.71	5.30



CENTER RELEASE • BREAKAWAY

MATERIAL • POLYACETAL

IN.	MM	PART #	A	B	C	D	E
			<small>METRIC</small>	<small>METRIC</small>	<small>METRIC</small>	<small>METRIC</small>	<small>METRIC</small>
5/8	16	BK 213-16	16.80	21.20	24.70	4.19	17.10
3/4	20	BK 213-20	19.60	23.80	28.50	4.80	19.60
1	25	BK 213-25	26.00	31.50	29.50	6.00	26.00
3/4	19	BK 213-2-19	19.00	23.20	25.15	4.19	19.00
1	25	BK 213-1-25	26.20	31.80	47.50	7.30	26.20



CENTER RELEASE • BREAKAWAY

MATERIAL • POLYACETAL

IN.	MM	PART #	A	B	C	D	E
			<small>METRIC</small>	<small>METRIC</small>	<small>METRIC</small>	<small>METRIC</small>	<small>METRIC</small>
1	25	BK-214-25	25.30	33.00	52.85	5.10	25.20
1	25	BK 214-1-25	26.00	32.00	32.40	4.50	26.00
1	25	BK 214-2-25	26.00	32.00	44.70	4.20	26.00

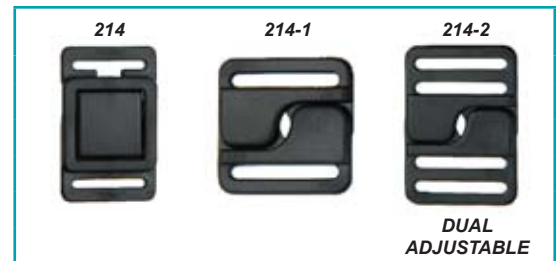

LANYARD • BREAKAWAY

MATERIAL • POLYACETAL

IN.	MM	PART #	A	B	C	D
			<small>METRIC</small>	<small>METRIC</small>	<small>METRIC</small>	<small>METRIC</small>
1 1/32	8.5	BK 663-8.5	3.80	10.20	28.20	4.00

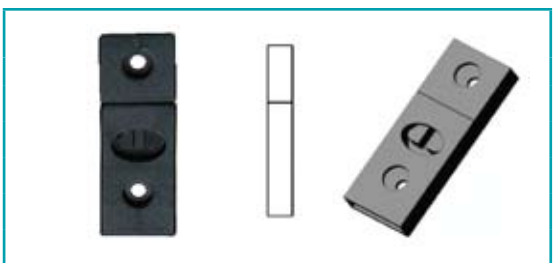

LANYARD • BREAKAWAY

MATERIAL • POLYACETAL

IN.	MM	PART #	A	B	C	D
			<small>METRIC</small>	<small>METRIC</small>	<small>METRIC</small>	<small>METRIC</small>
9/16	10	BK 670-10				
3/8	15	BK 670-15				



SAFETY • CAMBER

MATERIAL • POLYACETAL

IN.	MM	PART #	A	B	C	D
			<small>METRIC</small>	<small>METRIC</small>	<small>METRIC</small>	<small>METRIC</small>
3/8	10	BK 674-10	10.70	15.60	32.00	8.65
5/8	16	BK 675-16	16.32	23.01	52.02	9.75
3/4	20	BK 676-20	19.48	26.22	52.03	9.89



SPECIALTY SIDE RELEASE BUCKLES

Side release buckles offer quick release action along with webbing grip and adjustment. Many styles are available to enhance both appearance and function for numerous applications.

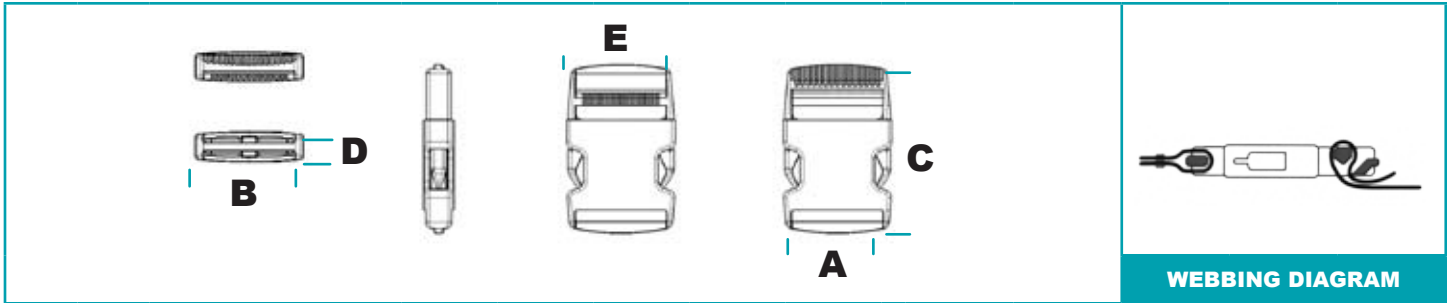

SIDE LOOP

MATERIAL • POLYACETAL

IN.	MM	PART #	A	B	C	D	E
			METRIC	METRIC	METRIC	METRIC	METRIC
1 1/2	38	BK 226-38	39.00	62.80	76.06	12.88	N/A



KEY • LOCK

MATERIAL • NYLON

IN.	MM	PART #	A	B	C	D	E
			METRIC	METRIC	METRIC	METRIC	METRIC
2	51	BK 224-51	52.70	63.10	79.20	16.50	52.50



QUICK CORD RELEASE

MATERIAL • POLYACETAL

IN.	MM	PART #	A	B	C	D
			METRIC	METRIC	METRIC	METRIC
7/16	10	BK 622-10	10.20	N/A	N/A	N/A

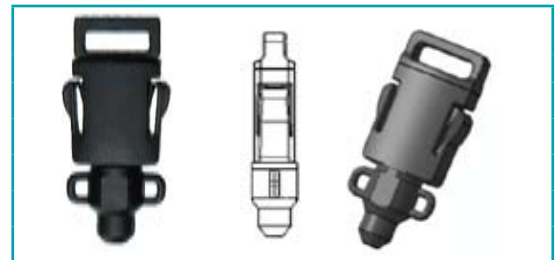

STANDARD

MATERIAL • POLYACETAL

IN.	MM	PART #	A	B	C	D	E
			METRIC	METRIC	METRIC	METRIC	METRIC
7/16	10	BK 625-10	7.90	13.50	24.80	6.30	N/A



MOUNTABLE • SIDE RELEASE

MATERIAL • POLYACETAL

IN.	MM	PART #	A	B	C	D	E
			METRIC	METRIC	METRIC	METRIC	METRIC
1	25	BK 209-25	26.36	33.16	68.05	13.60	5.30

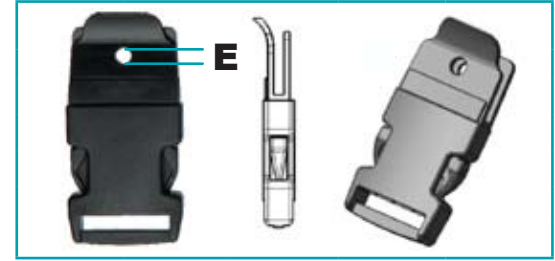

MOUNTABLE • CENTER RELEASE

MATERIAL • POLYACETAL

IN.	MM	PART #	A	B	C	D
			METRIC	METRIC	METRIC	METRIC
1	25	BK 215-25	4.80	26.31	47.80	13.57



MOUNTABLE • CENTER RELEASE

MATERIAL • POLYACETAL

IN.	MM	PART #	A	B	C	D
			METRIC	METRIC	METRIC	METRIC
7/16	11	BK 216-11	N/A	N/A	N/A	N/A
7/16	11	BK 216-1-11	N/A	N/A	N/A	N/A

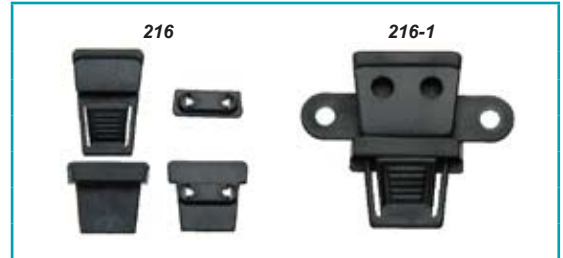

QUICK RELEASE

MATERIAL • POLYACETAL

IN.	MM	PART #	A	B	C	D
			METRIC	METRIC	METRIC	METRIC
7/16	10	BK 662-10	N/A	N/A	N/A	N/A



ABS • NICKEL PLATING

MATERIAL • POLYACETAL / ABS / NYLON

IN.	MM	PART #	A	B	C	D
			METRIC	METRIC	METRIC	METRIC
1	25	BK 206A-25	26.20	36.40	60.80	12.00



LADDER LOCKS

Ladder lock buckles minimize slippage of webbing and provide for easy release or tightening adjustments with one hand.

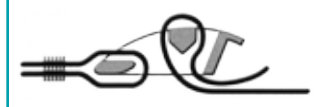
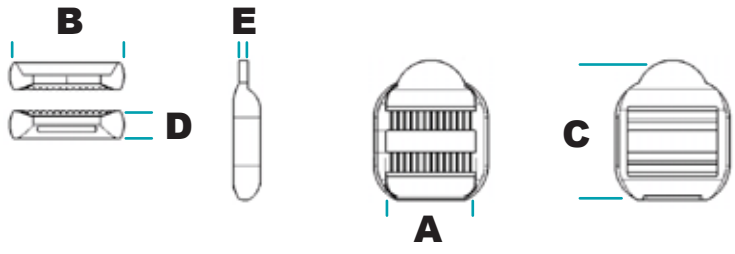

WEBBING DIAGRAM

CLASSIC

MATERIAL • POLYACETAL

IN.	MM	PART #	A	B	C	D	E
			METRIC	METRIC	METRIC	METRIC	METRIC
5/8	16	LL 503-16	16.80	21.20	33.00	6.60	6.60
3/4	20	LL 503-20	20.00	25.80	39.00	6.80	2.60
1	25	LL 503-25	26.00	30.76	38.78	7.02	N/A
1 1/4	32	LL 503-32	32.55	38.70	43.30	8.10	N/A
1 1/2	38	LL 503-38	39.00	45.50	50.50	8.40	N/A

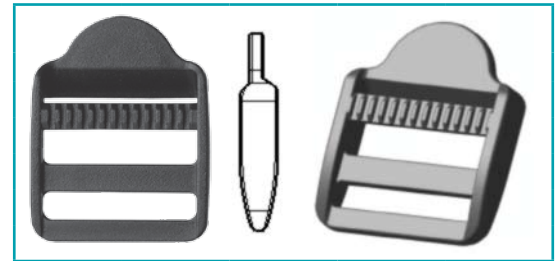

EURO STYLE

MATERIAL • POLYACETAL

IN.	MM	PART #	A	B	C	D	E
			METRIC	METRIC	METRIC	METRIC	METRIC
5/8	16	LL 503-1-16	15.95	21.24	31.15	8.00	N/A
3/4	20	LL 503-1-20	19.60	26.20	34.70	8.27	N/A
1	25	LL 503-1-25	26.20	33.66	35.06	9.24	N/A

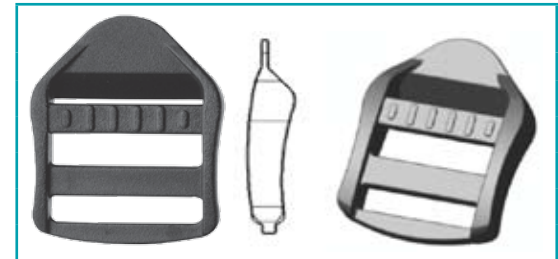

HEAVY DUTY

MATERIAL • POLYACETAL

IN.	MM	PART #	A	B	C	D	E
			METRIC	METRIC	METRIC	METRIC	METRIC
1	25	LL 501-25	24.80	33.48	49.80	9.77	2.80
1	25	LL 501-25-W*	24.80	33.48	49.80	9.77	2.80
1 1/2	38	LL 501-38	38.80	48.56	64.20	10.90	3.50
2	51	LL 501-51	51.90	65.90	78.42	24.81	N/A

*ALSO AVAILABLE IN WHITE

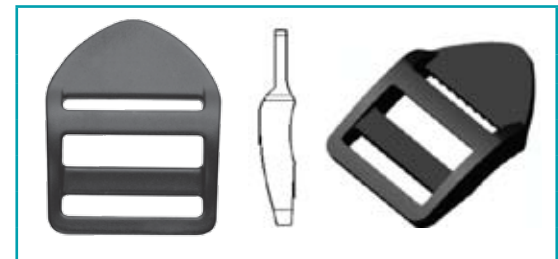

HEAVY DUTY • CONTOUR

MATERIAL • POLYACETAL

IN.	MM	PART #	A	B	C	D
			METRIC	METRIC	METRIC	METRIC
2	51	LL 517-51	52.17	63.95	65.65	12.70



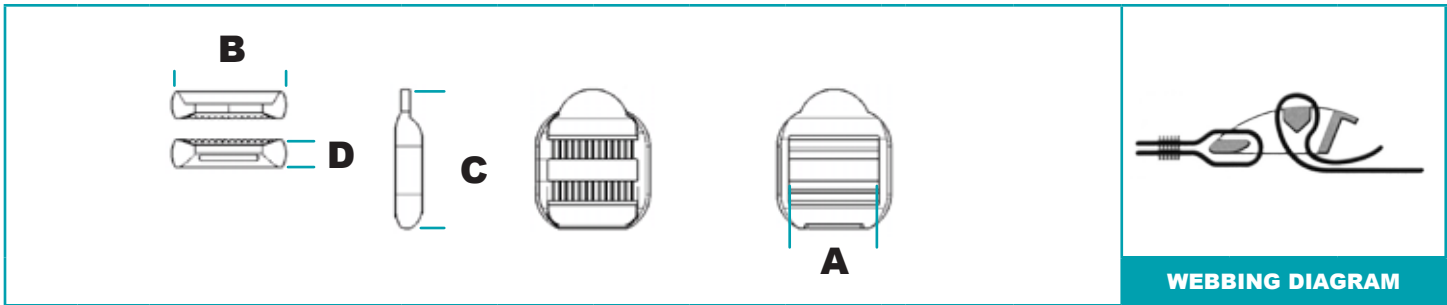

CONTOUR **MATERIAL • NYLON**

IN.	MM	PART #	A	B	C	D
			METRIC	METRIC	METRIC	METRIC
3/4	20	LL 516-20	20.50	27.80	31.97	10.60



CONTOUR **MATERIAL • POLYACETAL**

IN.	MM	PART #	A	B	C	D
			METRIC	METRIC	METRIC	METRIC
1	25	LL 501-1-25	26.00	32.60	37.60	9.67



DUAL **MATERIAL • POLYACETAL**

IN.	MM	PART #	A	B	C	D	E
			METRIC	METRIC	METRIC	METRIC	METRIC
1	25	LL 502-25	26.20	33.00	40.29	7.80	2.63



STANDARD **MATERIAL • NYLON**

IN.	MM	PART #	A	B	C	D
			METRIC	METRIC	METRIC	METRIC
3/4	20	LL 504-20	19.60	26.00	35.89	13.67
1	25	LL 504-25	26.20	32.80	46.80	16.37



STANDARD

MATERIAL • NYLON

IN.	MM	PART #	A	B	C	D
			METRIC	METRIC	METRIC	METRIC
3/4	20	LL 504-1-20N	19.88	27.12	39.60	8.27



STANDARD

MATERIAL • POLYACETAL

IN.	MM	PART #	A	B	C	D
			METRIC	METRIC	METRIC	METRIC
1	25	LL 502-1-25	25.80	33.04	31.28	10.09



3-BAR SLIDES

3-bar slides secure loose webbing and also provide length adjustment on strap assemblies. Available in a variety of sizes and styles for varying applications and webbing sizes and thicknesses.

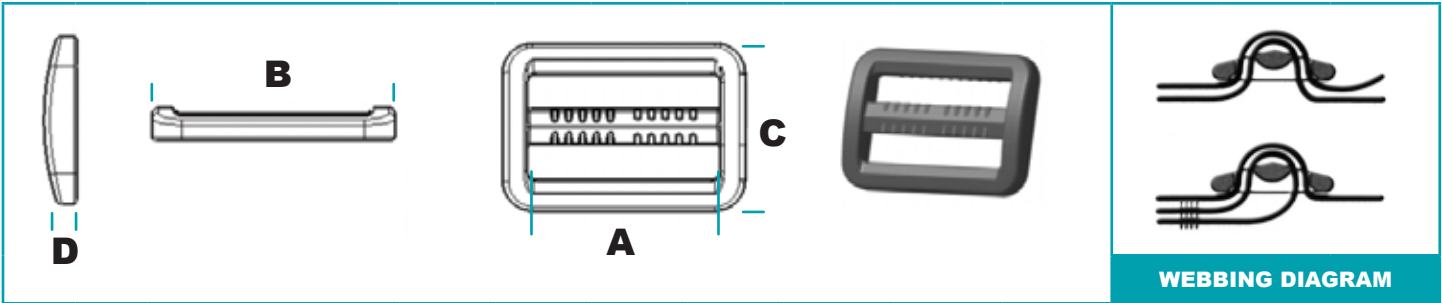

STANDARD

MATERIAL • POLYACETAL

IN.	MM	PART #	METRIC			
			A	B	C	D
5/8	16	SL 512-16	16.70	23.30	23.30	5.10
3/4	20	SL 512-20	20.00	26.50	24.00	5.30
1	25	SL 512-25	26.80	33.60	25.70	5.30
1 1/4	32	SL 512-32	32.10	40.20	27.60	5.40
1 1/2	38	SL 512-38	38.80	48.00	32.30	6.60
1 3/4	45	SL 512-45	45.40	54.90	32.80	6.60
2	51	SL 512-51	51.20	60.80	34.30	6.70

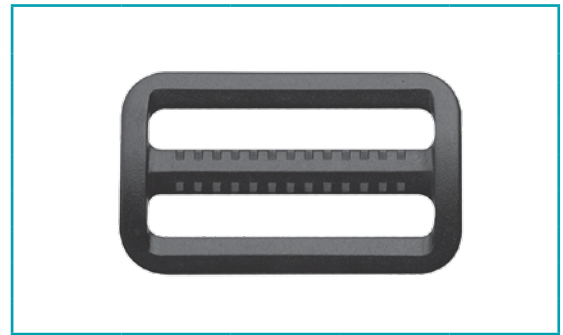

HEAVY DUTY

MATERIAL • POLYACETAL

IN.	MM	PART #	METRIC			
			A	B	C	D
5/8	16	SL 511-16	16.10	22.95	22.20	4.95
3/4	20	SL 511-20	20.00	27.40	23.40	5.35
1	25	SL 511-25	26.60	33.40	23.50	4.59
1 1/4	32	SL 511-32	32.30	41.00	27.50	4.80
1 1/2	38	SL 511-38	37.80	47.90	33.85	6.10
1 3/4	45	SL 511-45	45.50	55.40	35.08	6.10
2	51	SL 511-51	50.90	61.00	37.60	7.80



SQUARE WIDE MOUTH

MATERIAL • POLYACETAL

IN.	MM	PART #	METRIC			
			A	B	C	D
1/2	13	SL 510-13	13.50	21.10	19.60	4.40
5/8	16	SL 510-16	16.40	23.40	23.70	4.20
3/4	20	SL 510-20	19.70	28.00	25.70	4.60
1	25	SL 510-25	26.20	34.80	32.00	5.00
1 3/4	32	SL 510-32	32.50	41.50	39.50	6.70
1 1/2	38	SL 510-38	38.60	47.55	39.20	6.60



SQUARE WIDE MOUTH

MATERIAL • POLYACETAL

IN.	MM	PART #	A	B	C	D
<small>METRIC METRIC METRIC METRIC METRIC METRIC METRIC</small>						
5/8	16	SL 508-16	16.40	20.85	27.20	5.80
3/4	20	SL 508-20	19.90	26.50	30.45	6.10
1	25	SL 508-25	25.60	31.30	32.80	7.70



STANDARD

MATERIAL • POLYACETAL

IN.	MM	PART #	A	B	C	D
<small>METRIC METRIC METRIC METRIC METRIC METRIC METRIC</small>						
7/16	10	SL 506-10	10.20	13.20	10.50	.80
1/2	13	SL 506-13	13.20	17.80	13.70	3.00
5/8	16	SL 506-16	16.30	21.10	17.50	2.20
1	25	SL 506-25	25.80	30.80	17.40	2.1



SLIDE • SINGLE LOOP

MATERIAL • POLYACETAL

IN.	MM	PART #	A	B	C	D
<small>METRIC METRIC METRIC METRIC METRIC METRIC METRIC</small>						
1	25	SL 514-25	16.70	23.30	23.30	5.10



SLIDE • DOUBLE LOOP

MATERIAL • POLYACETAL

IN.	MM	PART #	A	B	C	D
<small>METRIC METRIC METRIC METRIC METRIC METRIC METRIC</small>						
3/4	20	SL 513-20	20.80	43.20	27.00	N/A
1	25	SL 513-25	26.00	40.00	30.40	N/A



SLIDE & KEEPER

MATERIAL • POLYACETAL

IN.	MM	PART #	A	B	C	D
<small>METRIC METRIC METRIC METRIC METRIC METRIC METRIC</small>						
3/16	5	SL 507-5	5.50	8.50	22.00	5.50
7/16	11	SL 507-11	11.20	15.00	25.30	5.50



STANDARD

MATERIAL • POLYACETAL

IN.	MM	PART #	A	B	C	D	E
<small>METRIC METRIC METRIC METRIC METRIC METRIC METRIC METRIC</small>							
1	25	SL 515-25	26.80	32.91	30.00	7.00	18.20



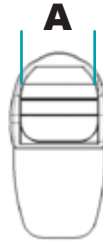

WEBBING DIAGRAM

SEWABLE

MATERIAL • POLYACETAL

IN.	MM	PART #	A	B	C	D	E	
			METRIC	METRIC	METRIC	METRIC	METRIC	METRIC
3/4	20	LP 409-20	20.00	27.63	20.18	3.92	1.23	
1	25	LP 409-25	29.00	38.60	N/A	2.74	1.02	
1 1/2	38	LP 409-38	N/A	N/A	N/A	N/A	N/A	
1 3/4	45	LP 409-45	45.60	54.00	21.10	3.00	1.00	



WEBBING DIAGRAM

SEWABLE

MATERIAL • POLYACETAL

IN.	MM	PART #	A	B	C	D	E	
			METRIC	METRIC	METRIC	METRIC	METRIC	METRIC
1	25	LL 407-25	26.00	33.20	62.60	7.70	1.00	



Meade
Distributing
**YOUR MARINE
HEADQUARTERS**

6 ANGLE DOUBLE BAR RINGS

6-angle double bar rings prevent webbing from twisting and keeps webbing taut for a smoother appearance. The bar rings also help center weight and create a strong attaching point.

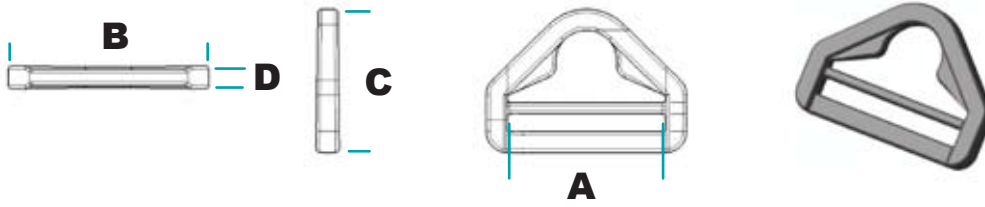

OPEN

MATERIAL • POLYACETAL

IN.	MM	PART #	A	B	C	D
<small>METRIC METRIC METRIC METRIC METRIC METRIC METRIC</small>						
3/4	20	LP 417-20	19.90	26.50	20.20	4.38
1	25	LP 417-25	26.80	34.60	27.20	4.76
1 1/4	32	LP 417-32	32.20	41.40	29.00	4.97
1 1/2	38	LP 417-38	38.70	48.90	34.80	5.68
2	51	LP 417-51	51.50	62.30	39.50	4.70



CLOSED

MATERIAL • POLYACETAL

IN.	MM	PART #	A	B	C	D
<small>METRIC METRIC METRIC METRIC METRIC METRIC METRIC</small>						
3/4	20	LP 418-20	20.00	27.60	26.60	5.07
1	25	LP 418-25	26.20	33.80	26.50	5.12
1 1/4	32	LP 418-32	32.50	42.30	30.50	5.94
1 1/2	38	LP 418-38	39.40	49.40	31.00	5.63
2	51	LP 418-51	52.40	62.60	38.00	5.94



6-ANGLE

MATERIAL • POLYACETAL

IN.	MM	PART #	A	B	C	D
<small>METRIC METRIC METRIC METRIC METRIC METRIC METRIC</small>						
1	25	LP 415-25	26.00	35.60	5.42	28.69
1 1/4	32	LP 415-32	32.00	43.00	5.63	30.30
1 1/2	38	LP 415-38	38.50	49.10	5.74	31.80



DOUBLE BAR

MATERIAL • POLYACETAL

IN.	MM	PART #	A	B	C	D
<small>METRIC METRIC METRIC METRIC METRIC METRIC METRIC</small>						
2	51	DR 416-51	52.00	62.26	34.80	6.16



STRAP DIVIDERS

Strap dividers provide a means of intersecting webbing from multiple angles.

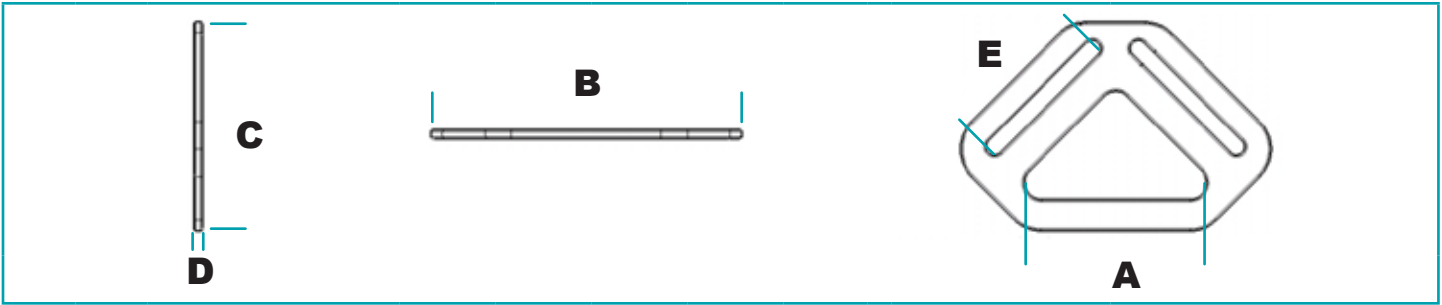

STRAP DIVIDER

MATERIAL • POLYACETAL

IN.	MM	PART #	A	B	C	D	E
			METRIC	METRIC	METRIC	METRIC	METRIC
3/4	16	PD 713-1	44.00	75.00	50.00	2.20	37.40



STRAP DIVIDER

MATERIAL • POLYACETAL

IN.	MM	PART #	A	B	C	D	E
			METRIC	METRIC	METRIC	METRIC	METRIC
1 1/2	38	PD 713-2	38.00	44.38	25.00	5.60	18.46



GALLUSES

Galluses provide a means of attachment to another object or suspender.

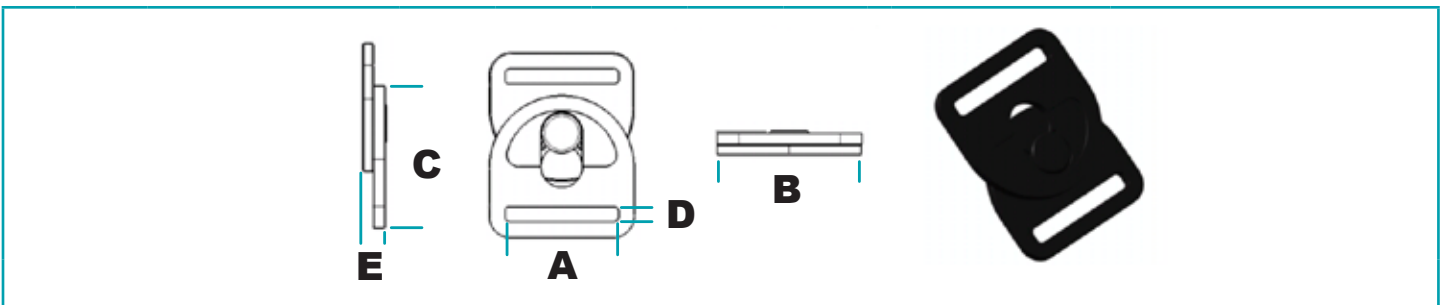

HOOK

MATERIAL • POLYACETAL

IN.	MM	PART #	A	B	C	D	E
			METRIC	METRIC	METRIC	METRIC	METRIC
1	25	SH 307-25	29.00	40.00	37.20	4.50	3.60
1 1/2	38	SH 307-1-38	30.20	50.20	49.00	5.20	3.80

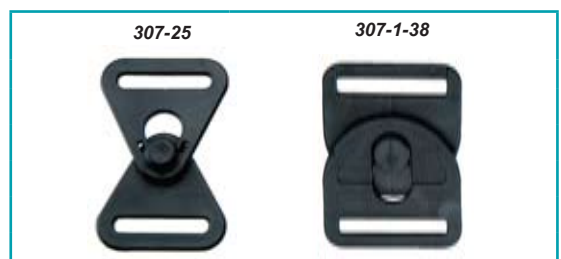

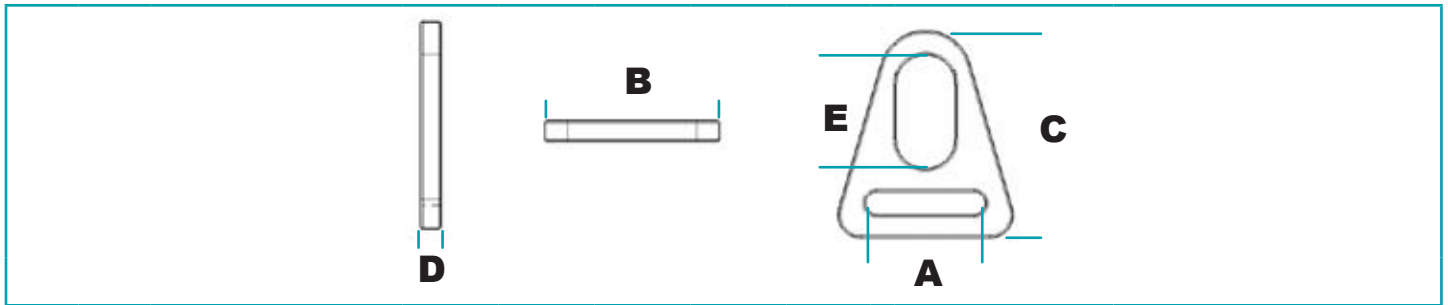

LOOP MATERIAL • POLYACETAL

IN.	MM	PART #	A	B	C	D	E	
			METRIC	METRIC	METRIC	METRIC	METRIC	METRIC
1	25	LP 320	26.30	38.00	45.00	4.50	24.80	



LOOP • HEAVY DUTY MATERIAL • POLYACETAL

IN.	MM	PART #	A	B	C	D	E	
			METRIC	METRIC	METRIC	METRIC	METRIC	METRIC
1 1/2	38	LP 321	38.80	48.80	45.00	4.30	24.60	

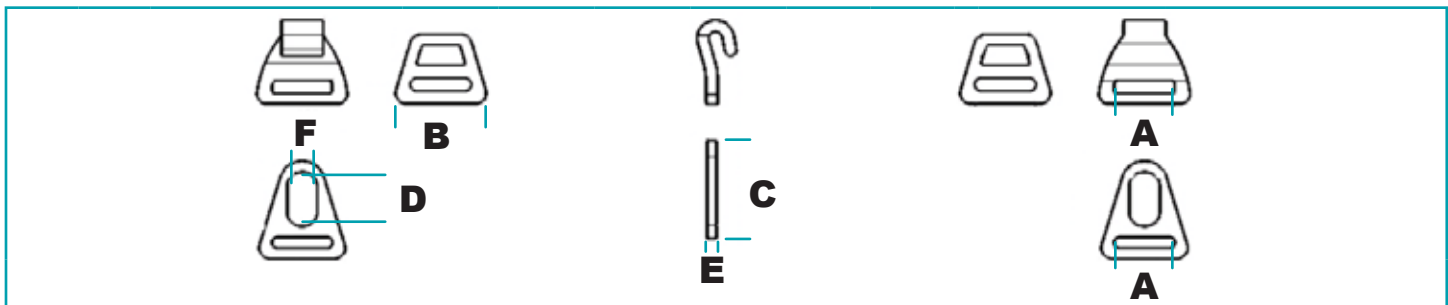
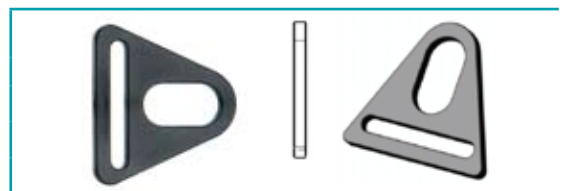

LOOP 3 PC SET MATERIAL • POLYACETAL

IN.	MM	PART #	A	B	C	D	E	F
			METRIC	METRIC	METRIC	METRIC	METRIC	METRIC
1	25	LP 322	26.30	40.00	45.00	24.80	4.50	13.00



LOOP • HEAVY DUTY • 3 PC SET MATERIAL • POLYACETAL

IN.	MM	PART #	A	B	C	D	E	F
			METRIC	METRIC	METRIC	METRIC	METRIC	METRIC
1 1/2	38	LP 323	38.80	54.00	45.00	24.60	4.30	13.00



SQUARE LOOPS

Loops join two pieces of webbing together and are ideal for non-adjustment applications.

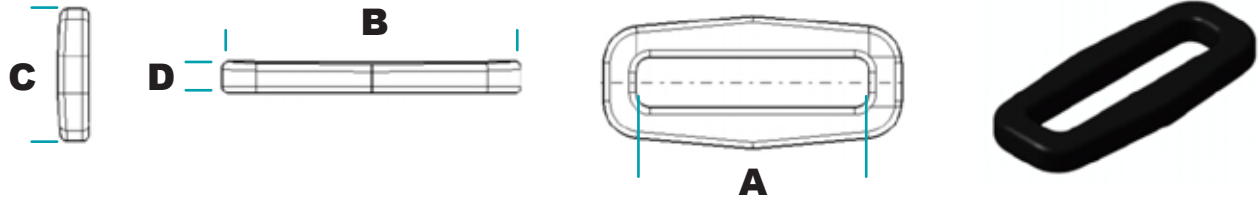

STANDARD

MATERIAL • POLYACETAL

IN.	MM	PART #	A	B	C	D
METRIC METRIC METRIC METRIC METRIC METRIC METRIC						
5/8	16	LP 419-16	16.30	23.30	3.72	14.39
3/4	20	LP 419-20	19.80	26.60	4.40	14.79
1	25	LP 419-25	26.40	34.40	3.50	16.20
1 1/4	32	LP 419-32	32.70	41.90	4.45	18.50
1 1/2	38	LP 419-38	39.00	49.00	4.00	19.90
1 3/4	45	LP 419-45	45.00	54.60	4.00	20.20
2	51	LP 419-51	52.00	62.00	4.68	20.80



CLASSIC

MATERIAL • POLYACETAL

IN.	MM	PART #	A	B	C	D
METRIC METRIC METRIC METRIC METRIC METRIC METRIC						
3/4	20	LP 420-20	20.36	28.10	16.60	5.60
1	25	LP 420-25	27.00	36.00	19.50	5.50
1 1/4	32	LP 420-32	32.80	42.00	19.99	6.00
1 1/4	32	LP 420-1-32	32.00	41.00	23.90	4.00
1 1/2	38	LP 420-38	38.80	48.00	19.50	6.00
2	51	LP 420-51	51.70	62.20	20.20	6.60



CLASSIC • WIDE MOUTH

MATERIAL • POLYACETAL

IN.	MM	PART #	A	B	C	D
METRIC METRIC METRIC METRIC METRIC METRIC METRIC						
1	25	LP 422-25	26.10	34.50	22.60	6.00
1 1/4	32	LP 422-32	32.00	40.80	23.10	6.50
1 1/2	38	LP 422-38	39.00	48.60	24.40	6.40
2	51	LP 422-51	51.50	61.80	24.70	6.20



SQUARE • WIDE MOUTH

MATERIAL • POLYACETAL

IN.	MM	PART #	A	B	C	D
METRIC METRIC METRIC METRIC METRIC METRIC METRIC						
1	25	LP 421-25	26.40	36.80	27.40	6.40
1 1/4	32	LP 421-32	32.60	43.00	27.20	6.40
1 1/2	38	LP 421-38	39.00	49.40	27.40	6.20
2	51	LP 421-51	51.80	62.20	27.20	6.20



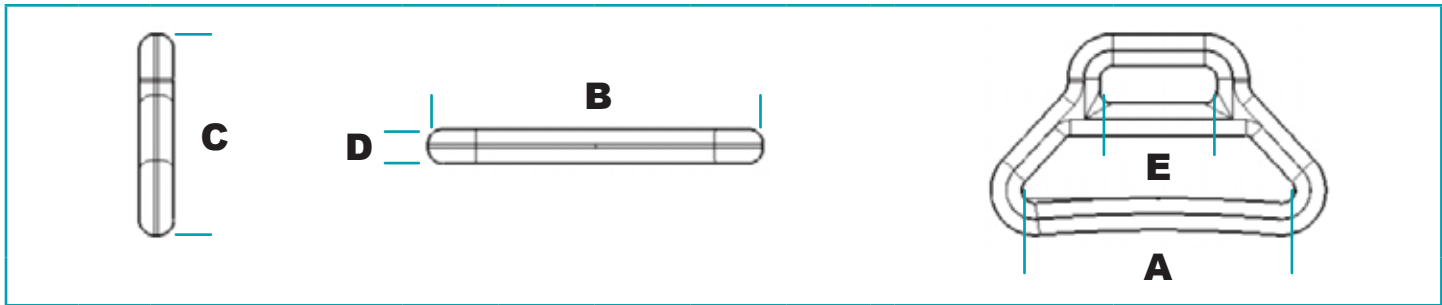

DOUBLE • LOOP

MATERIAL • POLYACETAL

IN.	MM	PART #	A	B	C	D	E
			METRIC	METRIC	METRIC	METRIC	METRIC
1 1/2	38	LP 425-38	42.70	52.40	31.33	5.40	18.30

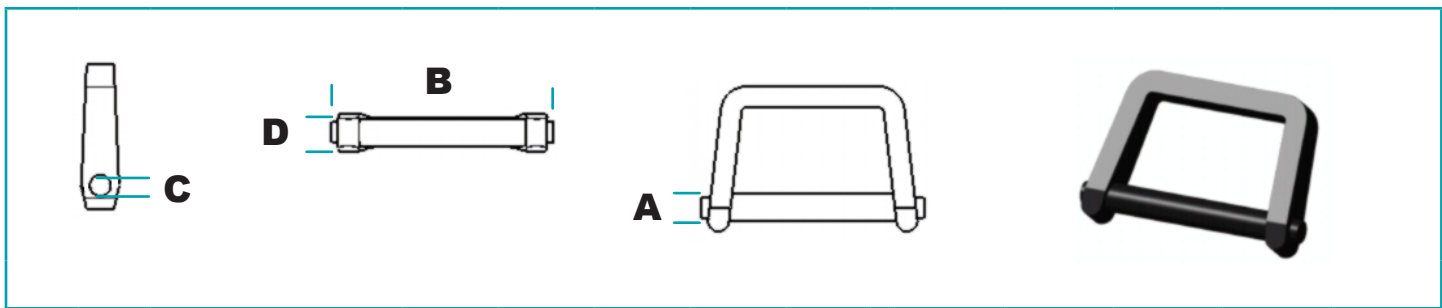

DETACHABLE PIN

MATERIAL • POLYACETAL

IN.	MM	PART #	A	B	C	D
			METRIC	METRIC	METRIC	METRIC
1 1/4	32	LP 404-32	5.20	42.40	4.00	7.19



HEAVY DUTY

MATERIAL • POLYACETAL

IN.	MM	PART #	A	B	C	D
			METRIC	METRIC	METRIC	METRIC
1	25	LP 401-25	26.00	35.50	28.50	3.20
1 1/2	38	LP 401-38	38.60	48.00	28.60	3.20
2	51	LP 401-51	51.40	50.50	29.20	3.20
2	51	LP 401-1-51	51.30	60.50	25.00	5.20



BELT LOOPS

Belt loops are used in conjunction with adjustable buckles, with the belt loop stays offering a means of securing the loose end of the webbing.

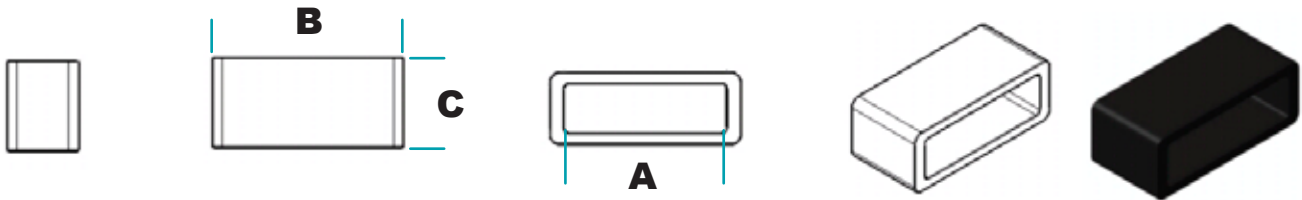

ADJUSTER

MATERIAL • POLYACETAL

IN.	MM	PART #	A	B	C
			METRIC	METRIC	METRIC
5/8	16	LP 405-16	17.00	20.00	9.40
3/4	20	LP 405-20	20.30	23.20	9.50
1	25	LP 405-25	26.20	29.40	8.80
1 1/4	32	LP 405-32	32.80	35.80	9.00



HEAVY DUTY • ADJUSTER

MATERIAL • POLYACETAL

IN.	MM	PART #	A	B	C
			METRIC	METRIC	METRIC
5/8	16	LP 406-16	17.00	21.00	10.60
3/4	20	LP 406-20	N/A	24.00	11.80
1	25	LP 406-25	26.60	32.00	11.20
1 1/2	38	LP 406-38	39.20	45.60	15.80
1 1/2	38	LP 406-2-38	40.40	49.20	20.30
2	51	LP 406-51	51.60	55.60	15.50
2	51	LP 406-1-51	52.60	59.20	15.80
2	51	LP 406-2-51	51.20	60.20	19.40



Meade
Distributing
**YOUR MARINE
HEADQUARTERS**

SPECIALTY LOOPS

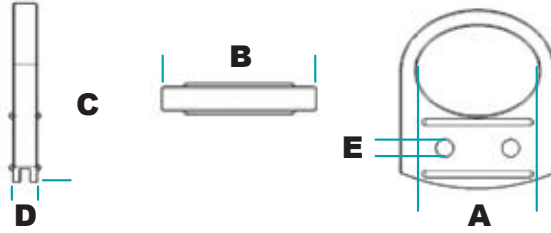

WEBBING END • O-RING

MATERIAL • POLYACETAL

IN.	MM	PART #	A		B		C		D		E	
			METRIC	METRIC	METRIC	METRIC	METRIC	METRIC	METRIC	METRIC	METRIC	METRIC
1 1/2	38	LP 426-38	35.50	44.50	51.00	7.00	5.00					

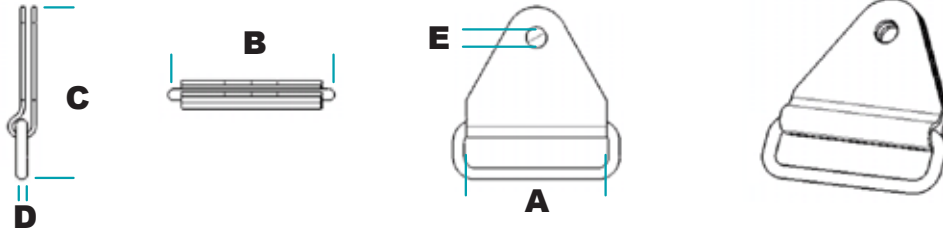

CHAFE TAB

MATERIAL • POLYACETAL

IN.	MM	PART #	A		B		C		D		E	
			METRIC	METRIC	METRIC	METRIC	METRIC	METRIC	METRIC	METRIC	METRIC	METRIC
1	25	LP 424-25	26.00	32.00	38.23	3.00	4.50					
1 1/4	38	LP 424-38	38.50	44.50	45.93	3.00	5.50					
2	51	LP 424 -51	51.40	57.40	46.31	3.00	5.50					



Meade
Distributing

FOR ALL YOUR SETTING EQUIPMENT NEEDS

D-RINGS

D-rings center weight and provide a means of attachment for snap hooks or other types of hardware. Several styles are available to complement various applications.

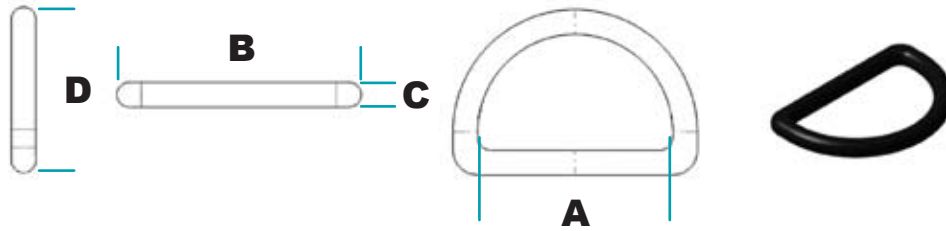

CLASSIC

MATERIAL • POLYACETAL

IN.	MM	PART #	A	B	C	D
<small>METRIC METRIC METRIC METRIC METRIC METRIC METRIC</small>						
1/2	13	DR 412-13	13.27	19.31	2.80	12.65
3/4	20	DR 412-20	20.01	27.03	3.20	20.08
1	25	DR 412-25	26.20	34.20	4.00	24.10
1 1/4	32	DR 412-32	33.94	42.80	4.20	25.80
1 1/2	38	DR 412-38	39.39	49.48	5.00	33.40
2	51	DR 412-51	51.98	64.47	6.00	N/A



HEAVY DUTY • CLASSIC

MATERIAL • POLYACETAL

IN.	MM	PART #	A	B	C	D
<small>METRIC METRIC METRIC METRIC METRIC METRIC METRIC</small>						
7/16	10	LP 403-10	11.40	16.60	2.60	16.60



HEAVY DUTY

MATERIAL • POLYACETAL

IN.	MM	PART #	A	B	C	D
<small>METRIC METRIC METRIC METRIC METRIC METRIC METRIC</small>						
3/4	20	DR 411-20	20.30	29.10	4.60	25.10
1	25	DR 411-25	26.00	36.40	5.53	27.80
1 1/4	32	DR 411-32	32.00	41.20	5.70	27.64
1 1/2	38	DR 411-38	38.60	49.40	5.96	28.80
2	51	DR 411-51	54.00	66.20	5.80	31.00



HEAVY DUTY • WIDE MOUTH

MATERIAL • POLYACETAL

IN.	MM	PART #	A	B	C	D
<small>METRIC METRIC METRIC METRIC METRIC METRIC METRIC</small>						
3/4	20	DR 413-20	19.60	27.60	3.60	23.80
1	25	DR 413-25	26.30	34.70	3.20	28.40
1 1/4	32	DR 413-32	32.50	40.90	4.40	32.30
1 1/2	38	DR 413-38	39.00	48.00	4.50	36.00
1 3/4	45	DR 413-45	44.80	54.60	4.10	39.20
2	51	DR 413-51	51.70	62.10	4.20	42.20



LOOP • D-RING

MATERIAL • POLYACETAL

IN.	MM	PART #	A	B	C	D
			METRIC	METRIC	METRIC	METRIC
1	25	LP 423-25	25.90	33.50	4.00	31.80



LOOP • SQUARE NOTCH

MATERIAL • POLYACETAL

IN.	MM	PART #	A	B	C	D
			METRIC	METRIC	METRIC	METRIC
1	25	LP 336	25.80	53.40	3.50	27.60

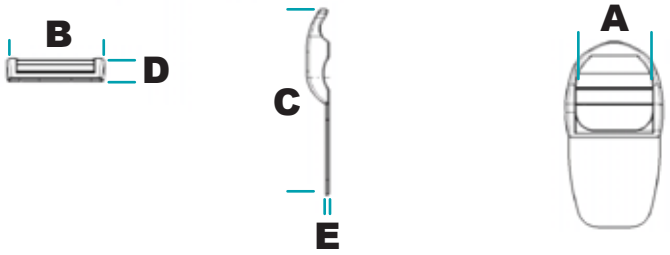

WEBBING DIAGRAM

SEWABLE D-RINGS

MATERIAL • POLYACETAL

IN.	MM	PART #	A	B	C	D	E
			METRIC	METRIC	METRIC	METRIC	METRIC
3/4	20	DR 408-20	19.90	28.50	42.10	4.30	.80
1	25	DR 408-25	26.40	35.80	45.30	5.00	.80
1 1/2	38	DR 408-38	38.40	46.80	56.00	5.5	.80



Ask a sales representative about our extensive value added services.



TRI-RINGS

Tri-rings anchor hook and loop or webbing straps, help center weight and eliminate bunching.

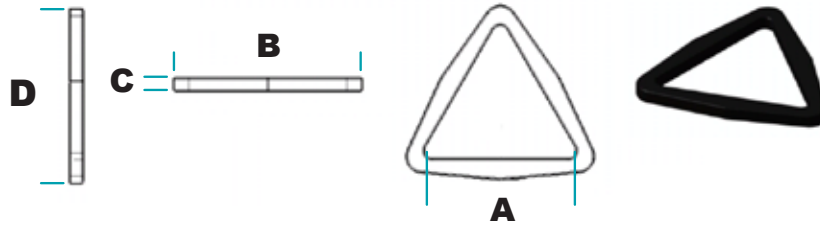

CLASSIC

IN.	MM	PART #	A	B	C	D
<small>METRIC METRIC METRIC METRIC METRIC METRIC METRIC</small>						
3/4	20	TR 414-20	19.70	30.73	3.80	29.00
1	25	TR 414-25	26.17	36.03	3.60	33.99
1 1/4	32	TR 414-32	32.50	41.48	3.90	44.70
1 1/2	38	TR 414-38	39.00	47.44	4.00	50.73
1 3/4	45	TR 414-45	46.00	57.08	4.30	N/A
2	51	TR 414-51	51.40	61.53	4.00	58.19

MATERIAL • POLYACETAL



HEAVY DUTY • ROUNDED

IN.	MM	PART #	A	B	C	D
<small>METRIC METRIC METRIC METRIC METRIC METRIC METRIC</small>						
3/4	20	LP 402-20	19.00	27.80	4.20	26.00

MATERIAL • POLYACETAL



O-RINGS

O-rings are ideal in non-adjustment applications, and also join together two pieces of webbing.

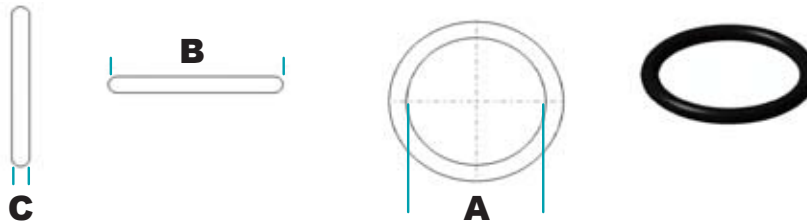

CLASSIC

IN.	MM	PART #	A	B	C
<small>METRIC METRIC METRIC METRIC METRIC</small>					
3/8	10	OR 410-09	10.00	14.80	2.20
3/4	20	OR 410-20	20.50	27.30	3.20
1	25	OR 410-25	26.00	33.80	3.90
1 1/2	38	OR 410-38	38.60	48.40	4.90
2	51	OR 410-51	51.40	63.40	6.00

MATERIAL • POLYACETAL



TAB

IN.	MM	PART #	A	B	C
<small>METRIC METRIC METRIC METRIC METRIC</small>					
3	78	LP 338	77.80	88.80	5.50

MATERIAL • POLYACETAL



CLIPS • HOOKS

Clips and hooks are perfect for many applications including the safety, industrial, medical and consumer technical markets.

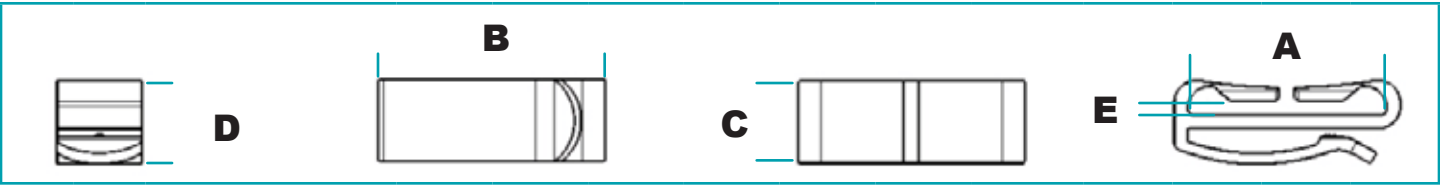

BELT CLIP • 3 PC SET

MATERIAL • POLYACETAL

IN.	MM	PART #	A	B	C	D	E
			METRIC	METRIC	METRIC	METRIC	METRIC
1	25	LP 325-25	26.40	30.00	11.20	11.50	2.09
1 1/2	38	LP 325-38	38.60	43.60	12.50	17.81	1.75
2	51	LP 325-51	51.30	56.30	12.50	17.18	1.75

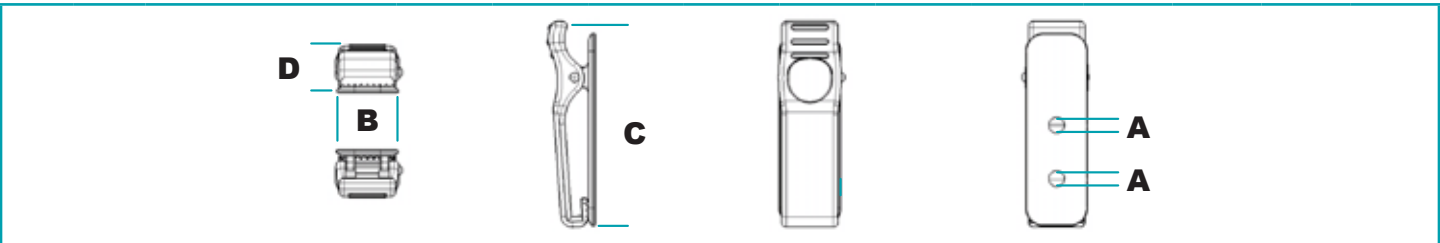

CASE CLIP

MATERIAL • ABS

IN.	MM	PART #	A	B	C	D
			METRIC	METRIC	METRIC	METRIC
3/16	5	LP 326	5.00	21.00	65.42	15.32

3 parts - ASSEMBLY REQUIRED

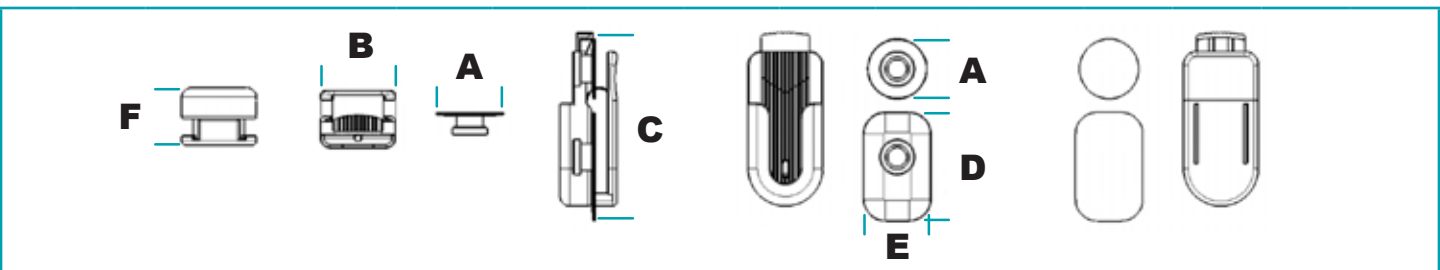

SWIVEL CELL PHONE CLIP

MATERIAL • ABS

IN.	MM	PART #	A	B	C	D	E	F
			METRIC	METRIC	METRIC	METRIC	METRIC	METRIC
7/8	22	SH 341	22.00	27.80	63.99	40.00	25.00	21.20



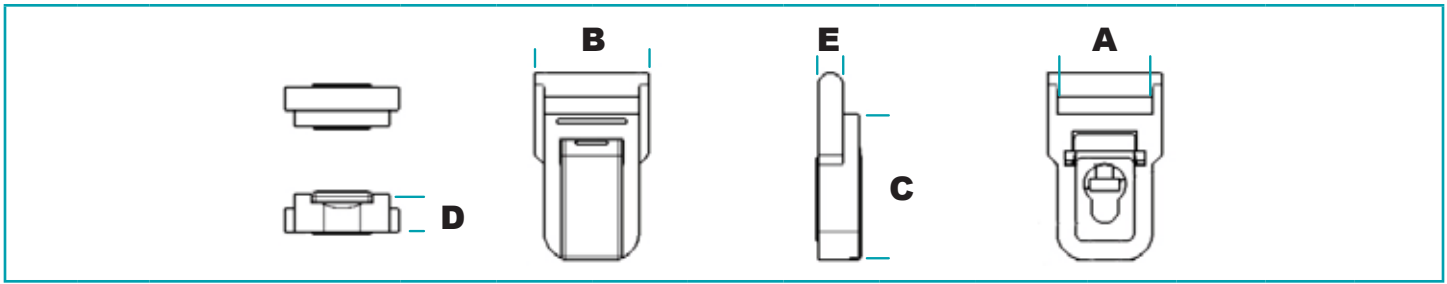

BELT CLIP / HOOK

MATERIAL • POLYACETAL

IN.	MM	PART #	A	B	C	D	E
			METRIC	METRIC	METRIC	METRIC	METRIC
3/4	20	LP 330	20.00	26.80	36.20	9.50	5.80

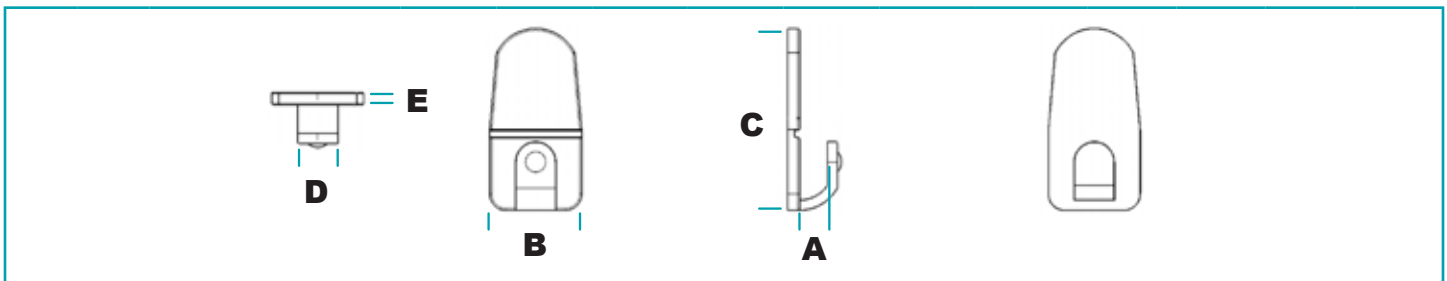

HANGING HOOK

MATERIAL • POLYPROPELENE

IN.	MM	PART #	A	B	C	D	E
			METRIC	METRIC	METRIC	METRIC	METRIC
9/32	7	LP 335	7.00	23.00	45.20	10.00	3.00

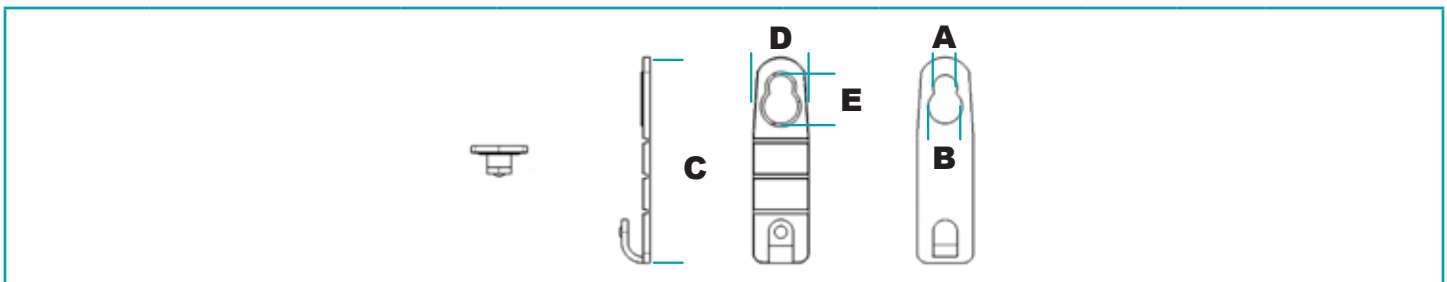
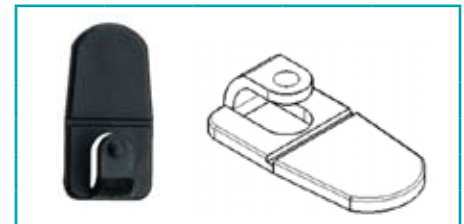

HANGING HOOK • FLEXIBLE

MATERIAL • POLYPROPELENE

IN.	MM	PART #	A	B	C	D	E
			METRIC	METRIC	METRIC	METRIC	METRIC
3/8	10	LP 334	10.00	14.00	83.80	23.00	19.80

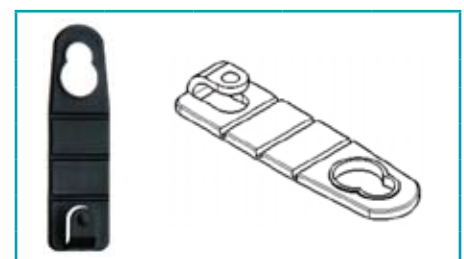

SNAP HOOKS

Snap hooks are available in a wide range of styles and sizes to accommodate many applications. Heavy-duty and weather resistant, the hooks are most commonly used in detachable shoulder strap assemblies.

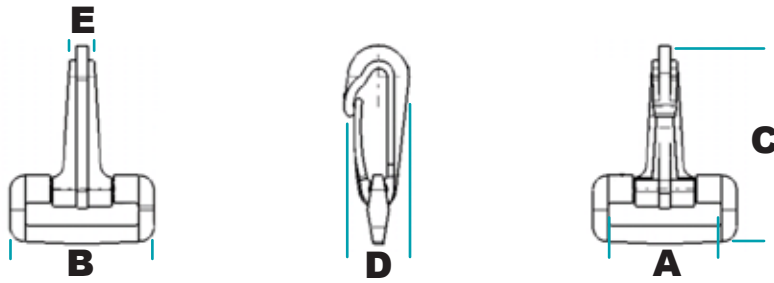

STANDARD

MATERIAL • POLYACETAL

IN.	MM	PART #	A	B	C	D	E
			METRIC	METRIC	METRIC	METRIC	METRIC
3/4	20	SH 309-20	20.00	28.40	56.69	18.79	7.08
1	25	SH 309-25	25.60	34.60	56.74	18.60	6.80
1 1/4	32	SH 309-32	32.60	41.00	56.54	18.67	7.08
1 1/2	38	SH 309-38	39.00	47.40	56.44	18.60	6.80

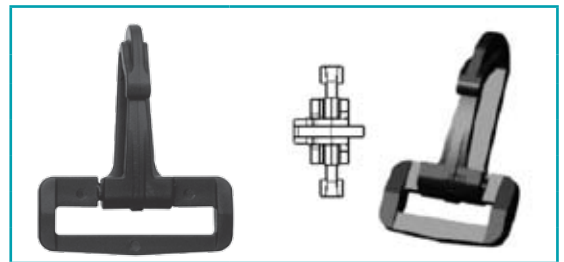

HEAVY DUTY

MATERIAL • POLYACETAL

IN.	MM	PART #	A	B	C	D	E
			METRIC	METRIC	METRIC	METRIC	METRIC
1 1/2	38	SH 308-38	38.80	47.50	57.24	18.60	6.80
1 3/4	45	SH 308-45	45.20	53.80	57.24	18.60	6.81
2	51	SH 308-51	51.60	60.20	56.98	18.60	6.81

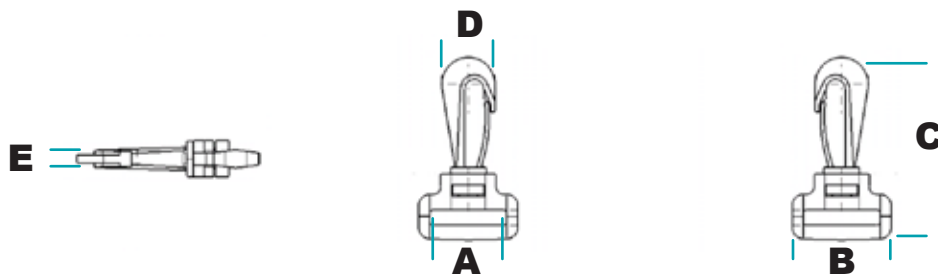
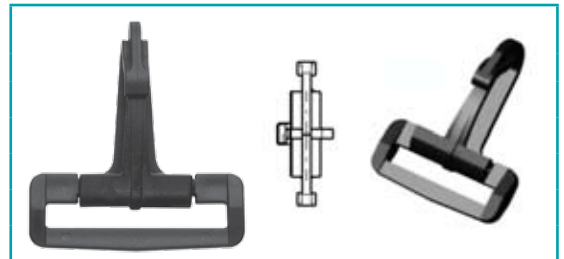

SWIVEL

MATERIAL • POLYACETAL

IN.	MM	PART #	A	B	C	D	E
			METRIC	METRIC	METRIC	METRIC	METRIC
3/4	20	SH 310-20	20.10	27.70	62.50	18.20	2.70
1	25	SH 310-25	26.40	34.00	62.50	18.20	2.70
1 1/4	32	SH 310-32	32.40	40.00	62.50	18.20	2.70
1 1/2	38	SH 310-38	39.60	47.20	62.50	18.20	2.70
1 3/4	45	SH 310-45	45.40	53.00	62.50	18.20	2.70
2	51	SH 310-51	51.60	59.20	62.50	18.20	2.70



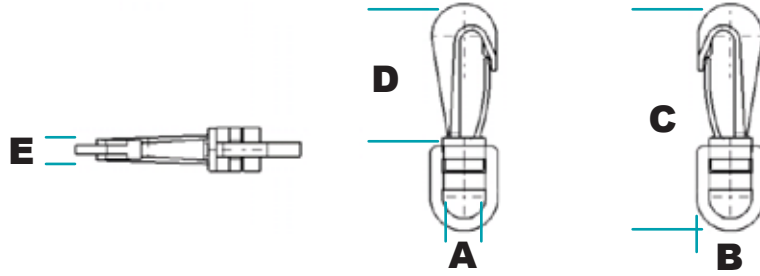

UNIVERSAL SWIVEL

MATERIAL • POLYACETAL

IN.	MM	PART #	A	B	C	D	E
			METRIC	METRIC	METRIC	METRIC	METRIC
3/4	20	SH 311-20	22.00	30.00	50.50	32.20	2.50
1	25	SH 311-25	25.80	33.80	50.50	32.20	2.50
1 1/4	32	SH 311-32	32.70	42.30	64.80	42.40	3.10
1 1/2	38	SH 311-38	38.60	49.00	65.70	42.40	3.10
2	51	SH 311-51	51.10	62.30	73.15	47.00	3.50



SWIVEL

MATERIAL • POLYACETAL

IN.	MM	PART #	A	B	C	D	E
			METRIC	METRIC	METRIC	METRIC	METRIC
3/4	20	SH 315-20	20.00	33.89	77.27	N/A	33.86
1	25	SH 315-25	25.40	40.16	77.59	N/A	18.35
1 1/2	38	SH 315-38	38.19	52.93	78.71	N/A	18.35
2	51	SH 315-51	51.25	65.80	79.24	N/A	18.35



CORD LOCK • SWIVEL

MATERIAL • POLYACETAL

IN.	MM	PART #	A	B	C	D	E
			METRIC	METRIC	METRIC	METRIC	METRIC
1/2	12	SH 312-12	12.20	19.20	63.80	39.90	2.70

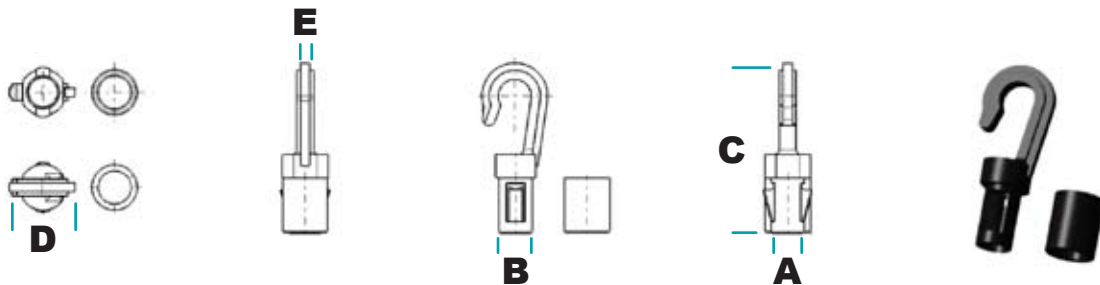
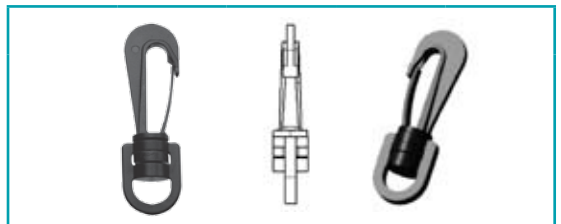

SHOCK CORD

MATERIAL • POLYACETAL

IN.	MM	PART #	A	B	C	D	E
			METRIC	METRIC	METRIC	METRIC	METRIC
1/4	7	CL 302-1-7	9.00	12.40	46.50	17.84	4.60
1/4	7	CL 302-2-7	9.00	12.40	46.50	17.84	4.60

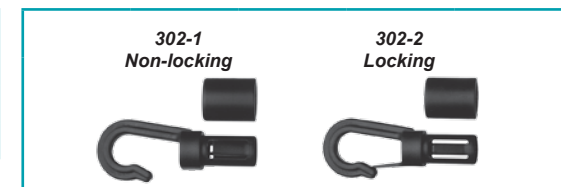

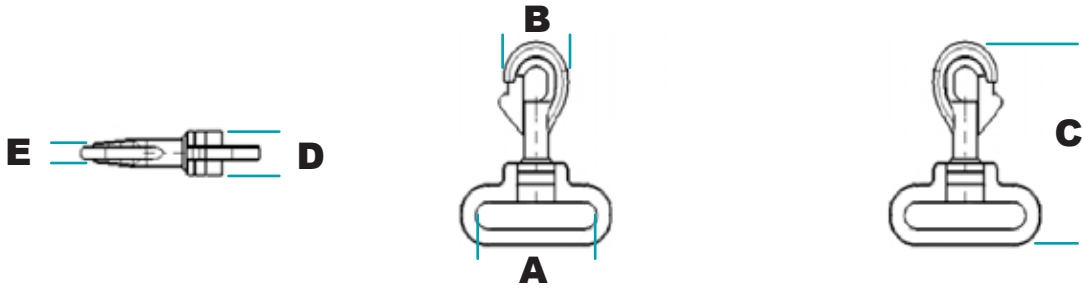

SPRING HOOK

MATERIAL • POLYACETAL

IN.	MM	PART #	A	B	C	D	E
			METRIC	METRIC	METRIC	METRIC	METRIC
1	25	SH 313-25	28.00	38.30	60.40	35.80	3.40
1 1/4	32	SH 313-32	34.66	44.66	60.40	35.80	3.40
1 1/2	38	SH 313-38	36.90	50.90	60.40	35.80	3.40
2	51	SH 313-51	53.60	63.60	60.40	35.80	3.40

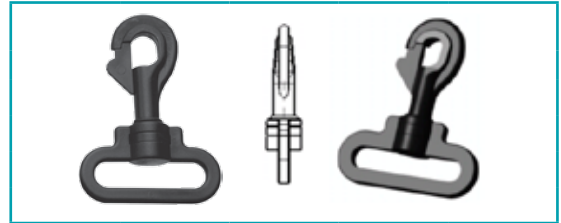

SMALL

MATERIAL • POLYACETAL

IN.	MM	PART #	A	B	C	D	E
			METRIC	METRIC	METRIC	METRIC	METRIC
5/16	8	SH 301	7.60	14.20	39.40	N/A	5.30
1/2	13	SH 301-1	13.70	8.70	27.50	N/A	N/A



O-RING

MATERIAL • POLYACETAL

IN.	MM	PART #	A	B	C	D	E
			METRIC	METRIC	METRIC	METRIC	METRIC
5/16	8	SH 304-1-08	7.15	11.24	N/A	N/A	4.00
7/16	10	SH 304-1-10	9.95	11.55	46.97	N/A	5.40

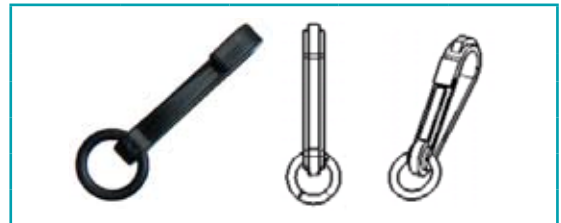

D-RING

MATERIAL • POLYACETAL

IN.	MM	PART #	A	B	C	D	E
			METRIC	METRIC	METRIC	METRIC	METRIC
3/4	20	SH 304-20	20.40	26.40	52.04	11.49	3.00
1	25	SH 304-25	25.70	33.70	57.00	N/A	5.40

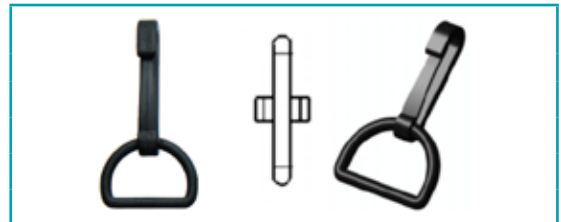

J-TYPE

MATERIAL • POLYACETAL

IN.	MM	PART #	A	B	C	D	E
			METRIC	METRIC	METRIC	METRIC	METRIC
1/2	13	SH 329	13.00	N/A	70.00	19.00	8.96
1/2	13	SH 329-1-0	13.00	N/A	70.00	19.00	8.96



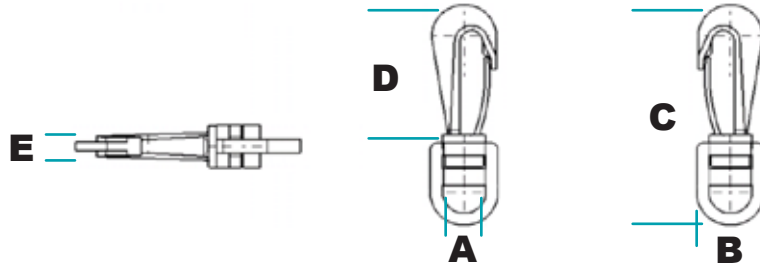

SWIVEL • SPRING

MATERIAL • POLYACETAL

IN.	MM	PART #	A	B	C	D	E
			METRIC	METRIC	METRIC	METRIC	METRIC
3/4	20	SH 331-20	19.70	31.70	62.90	N/A	2.79
1	25	SH 331-25	26.00	38.00	62.70	N/A	2.79
1 1/4	32	SH 331-32	32.40	44.40	62.70	N/A	2.79
1 1/2	38	SH 331-38	38.60	50.60	62.70	N/A	2.79
1 3/4	45	SH 331-45	44.70	56.70	62.70	N/A	2.79
2	51	SH 331-51	51.00	63.00	62.70	N/A	2.79



SWIVEL • CLASP

MATERIAL • POLYACETAL

IN.	MM	PART #	A	B	C	D	E
			METRIC	METRIC	METRIC	METRIC	METRIC
3/4	20	SH 332-20	19.70	31.70	62.90	N/A	2.79
1	25	SH 332-25	26.00	38.00	62.70	N/A	2.79
1 1/4	32	SH 332-32	32.40	44.40	62.70	N/A	2.79
1 1/2	38	SH 332-38	38.60	50.60	62.70	N/A	2.79
1 3/4	45	SH 332-51	51.00	63.00	62.70	N/A	2.79



KEY RING (ROUND)

MATERIAL • POLYACETAL

IN.	MM	PART #	A	B	C	D	E
			METRIC	METRIC	METRIC	METRIC	METRIC
23/32	18	SH 305	18.20	21.81	58.30	22.42	4.60



KEY RING (SQUARE)

MATERIAL • ABS

IN.	MM	PART #	A	B	C	D	E
			METRIC	METRIC	METRIC	METRIC	METRIC
23/32	18	SH 306	18.20	21.81	72.50	26.95	5.40



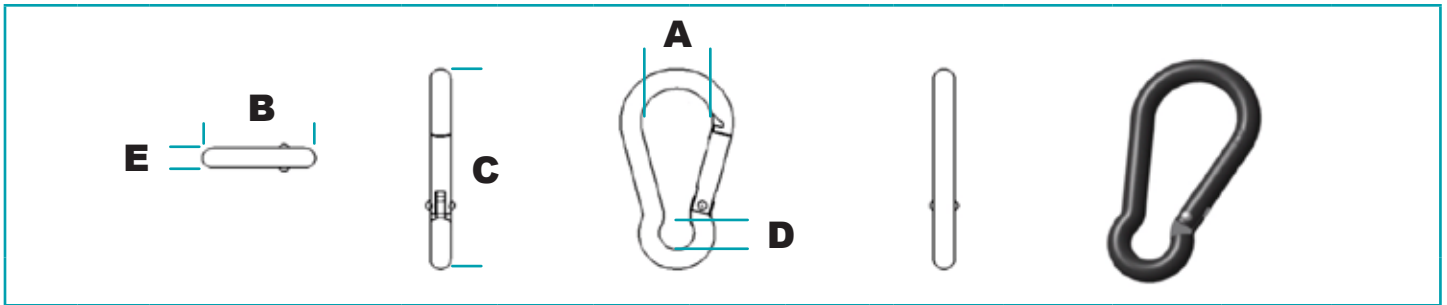

CARABINER HOOK

MATERIAL • POLYACETAL

IN.	MM	PART #	A	B	C	D	E
			METRIC	METRIC	METRIC	METRIC	METRIC
1 3/8	60	SH 337	20.00	31.60	59.40	9.60	5.80

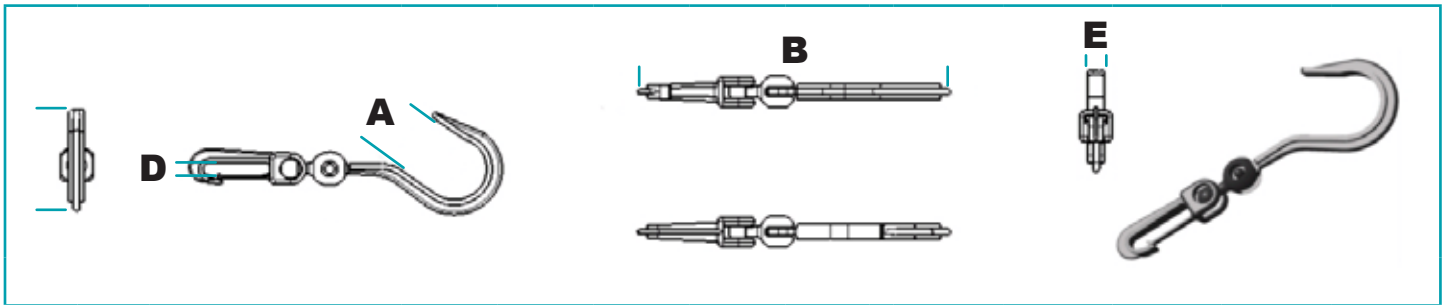

HANG HOOK

MATERIAL • POLYACETAL

IN.	MM	PART #	A	B	C	D	E
			METRIC	METRIC	METRIC	METRIC	METRIC
7/32	31	SH 317	31.20	163.89	52.77	9.25	7.80

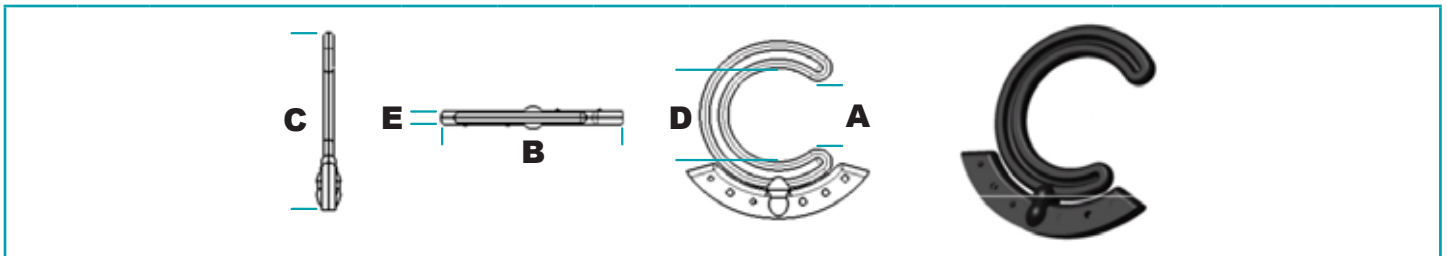

HANG HOOK

MATERIAL • POLYACETAL

IN.	MM	PART #	A	B	C	D	E
			METRIC	METRIC	METRIC	METRIC	METRIC
1 1/4	31	SH 318	30.72	78.40	80.17	42.60	4.50



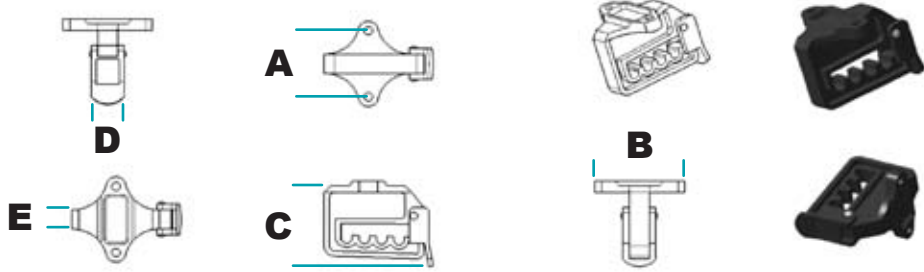

HANGER HOOK

MATERIAL • POLYACETAL

IN.	MM	PART #	A	B	C	D	E
			METRIC	METRIC	METRIC	METRIC	METRIC
1 1/2	38	SH 316	38.40	51.50	51.81	18.00	11.30
1 1/2	38	SH 316-1	40.00	51.50	51.81	19.00	11.30

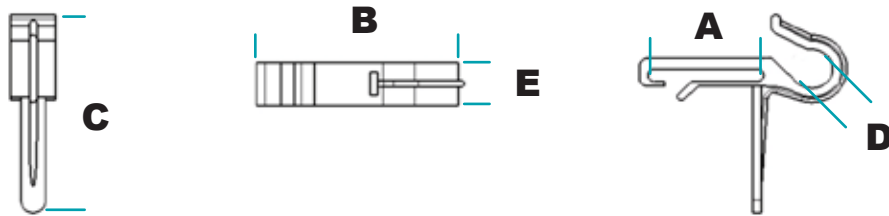

HANGER HOOK

MATERIAL • POLYACETAL

IN.	MM	PART #	A	B	C	D	E
			METRIC	METRIC	METRIC	METRIC	METRIC
1	25	LP 333	25.50	45.50	45.50	9.00	9.80

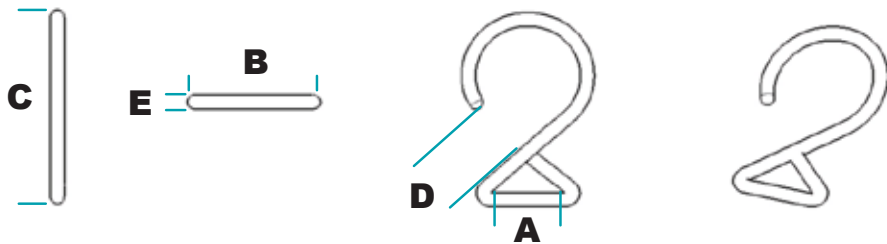

HANG HOOK

MATERIAL • POLYACETAL

IN.	MM	PART #	A	B	C	D	E
			METRIC	METRIC	METRIC	METRIC	METRIC
3/4	20	SH 319-20	19.84	40.60	62.20	22.00	4.20
7/8	22	SH 319-22	22.80	40.80	62.80	22.00	4.40
1	25	SH 319-25	26.10	41.40	64.20	22.00	4.20



SHOULDER PADS

Shoulder pads offer cushioned support in bag and luggage applications and are available in a variety of styles for versatile design. Lash tabs are sewn in and provide a means of accepting webbing on backpacks and other types of soft baggage.

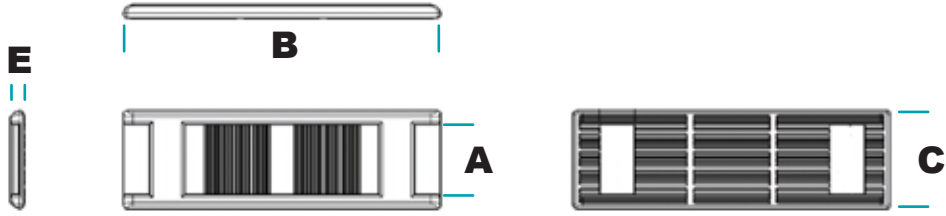

OVAL

MATERIAL • PVC

IN.	MM	PART #	A	B	C	E
<small>METRIC METRIC METRIC METRIC METRIC METRIC METRIC</small>						
1	25	PD 716-25	26.00	135.04	148.00	5.50
1 1/4	32	PD 716-32	32.00	148.00	45.00	5.50
1 1/2	38	PD 716-38	38.80	124.26	145.50	6.20
1 3/4	45	PD 716-45	45.50	154.00	50.40	6.40
2	51	PD 716-51	51.50	133.28	158.00	3.00



STANDARD

MATERIAL • PVC

IN.	MM	PART #	A	B	C	E
<small>METRIC METRIC METRIC METRIC METRIC METRIC METRIC</small>						
1	25	PD 717-25	28.50	146.00	10.50	6.50
1 1/4	32	PD 717-32	N/A	145.00	44.66	5.80
1 1/2	38	PD 717-38	39.00	149.00	16.00	5.60
1 3/4	45	PD 716-45	N/A	149.00	56.50	6.60
2	51	PD 716-51	51.50	133.28	158.00	3.00



HEAVY DUTY

MATERIAL • PVC

IN.	MM	PART #	A	B	C	E
<small>METRIC METRIC METRIC METRIC METRIC METRIC METRIC</small>						
2	51	PD 722-51	52.60	168.00	6.30	17.75



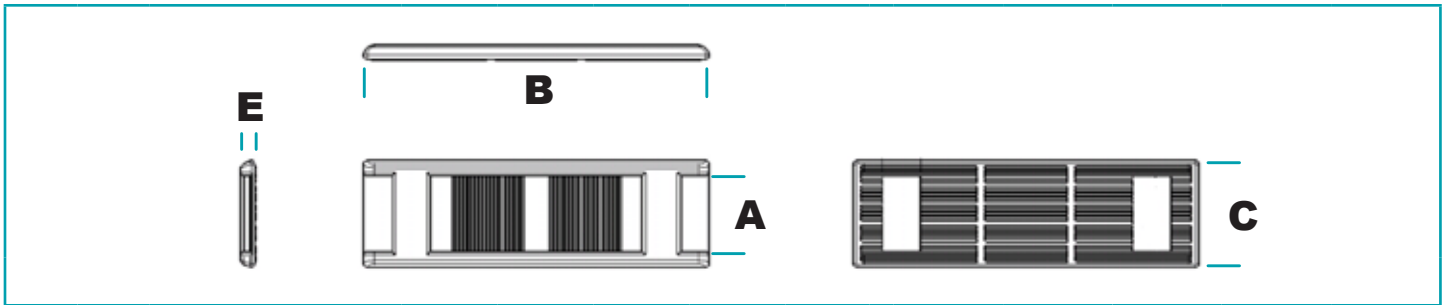

HEAVY DUTY

MATERIAL • POLYACETAL

IN.	MM	PART #	A	B	C	E
			METRIC	METRIC	METRIC	METRIC
1 1/2	38	PD 719-38	29.00	150.00	47.41	3.92

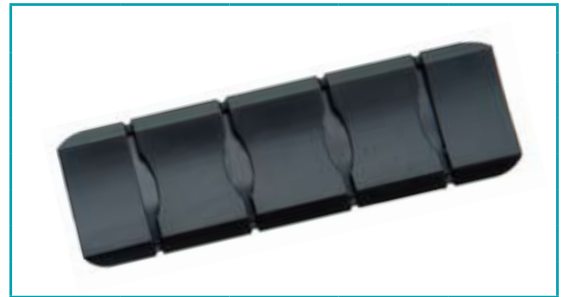

SQUARE

MATERIAL • PVC

IN.	MM	PART #	A	B	C	E
			METRIC	METRIC	METRIC	METRIC
1 1/4	32	PD 720-32	33.40	145.00	42.00	3.50



RADIAL

MATERIAL • PVC

IN.	MM	PART #	A	B	C	E
			METRIC	METRIC	METRIC	METRIC
1 1/2	38	PD 721-38	41.04	200.00	63.24	17.55



LASH TAB

MATERIAL • Hytre®

IN.	MM	PART #	A	B	C	E
			METRIC	METRIC	METRIC	METRIC
1	25	PD 718-25	20.33	98.00	43.00	7.50



LASH TAB

MATERIAL • Hytre®

IN.	MM	PART #	A	B	C	E
<small>METRIC METRIC METRIC METRIC METRIC METRIC METRIC</small>						
1 1/2	38	PD 711-38	38.50	66.60	43.50	6.00



LASH TAB

MATERIAL • Hytre®

IN.	MM	PART #	A	B	C	E
<small>METRIC METRIC METRIC METRIC METRIC METRIC METRIC</small>						
3/4	20	PD 712-1	20.00	50.80	50.80	3.50
1	25	PD 712-2	27.50	56.00	56.00	3.50



LASH TAB

MATERIAL • Hytre®

IN.	MM	PART #	A	B	C	E
<small>METRIC METRIC METRIC METRIC METRIC METRIC METRIC</small>						
1	25	PD 714-25	26.80	140.00	54.50	2.79

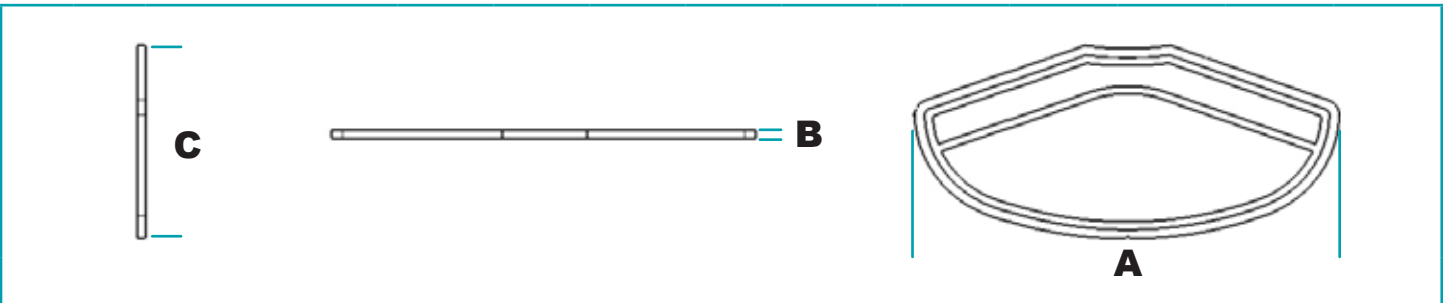
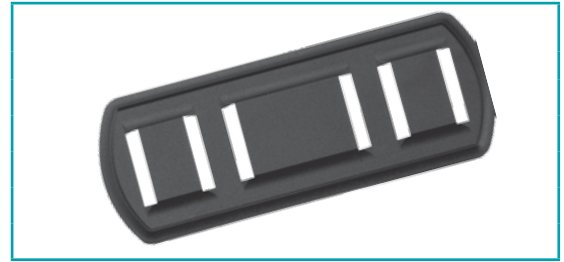

SEW-IN

MATERIAL • POLYACETAL

IN.	MM	PART #	A	B	C
<small>METRIC METRIC METRIC METRIC METRIC METRIC</small>					
1/4	130	PD 715	130.00	2.50	62.00



ZIPPER PULLS

Zipper pulls confine loose string ends by snapping onto the ends of cordage. Available in a wide variety of designs for versatility and style enhancement.



END

MATERIAL • POLYACETAL

IN.	MM	PART #	A	B	C	D	E	
			METRIC METRIC METRIC METRIC METRIC METRIC METRIC METRIC METRIC METRIC METRIC METRIC METRIC					
1/4	7	CL 647-0	5.50	16.90	36.65	5.77	6.78	
1/4	7	CL 647-38	5.50	16.90	36.65	5.77	6.78	



SWIVEL

MATERIAL • POLYACETAL

IN.	MM	PART #	A	B	C	D	E
			METRIC METRIC METRIC METRIC METRIC METRIC METRIC METRIC METRIC METRIC METRIC METRIC METRIC				
3/4	20	CL 664		10.00		5.60	
7/8	22	CL 666	3.84	20.33	38.08	10.90	6.40
1	25	CL 666-0					
1	25	CL 666-38					



SWIVEL

MATERIAL • POLYACETAL

IN.	MM	PART #	A	B	C	D	E
			METRIC METRIC METRIC METRIC METRIC METRIC METRIC METRIC METRIC METRIC METRIC METRIC METRIC				
3/4	20	CL 665					



SWIVEL

MATERIAL • POLYACETAL

IN.	MM	PART #	A	B	C	D	E
			METRIC METRIC METRIC METRIC METRIC METRIC METRIC METRIC METRIC METRIC METRIC METRIC METRIC				
3/4	20	CL 646					
7/8	22	CL 671					
1	25	CL 672					
7/8	22	CL 673					



CORD LOCKS & ENDS

Cord locks and cord ends provide a durable, weather-resistant means for securing cordage. Commonly used in the sporting equipment, bag and luggage industries, as well as in industrial applications.



PART #	A	B	C
	METRIC	METRIC	METRIC
CL 601	7.00	12.50	26.20
CL 602	6.90	12.50	25.35
CL 603	7.00	13.75	31.10
CL 604	7.60	14.90	33.80
CL 605	6.80	11.85	39.10
CL 607	7.00	12.40	29.10
CL 608	7.00	13.90	30.70
CL 609	6.80	13.70	28.27
CL 610	8.00	12.58	27.25
CL 611	7.50	17.97	21.50
CL 612	7.90	17.75	22.40
CL 613	8.39	17.58	21.60
CL 614	5.95	19.30	15.30
CL 615	7.00	12.85	29.30
CL 616	8.60	17.20	23.90
CL 617	5.80	15.80	24.80
CL 618	N/A	18.50	29.70
CL 619	7.00	13.00	30.00
CL 620-0	6.20	14.60	26.10
CL 621	7.00	17.00	29.95
CL 630	5.20	24.00	21.00
CL 634	6.80	12.80	36.60
CL 635	8.00	17.80	26.87
CL 636	8.00	20.90	26.74
CL 637	6.00	15.60	28.03
CL 638	8.75	16.90	25.15
CL 639	7.10	20.30	22.90
CL 640	4.60	20.60	23.20
CL 641	5.10	7.40	29.35
CL 642	6.80	25.59	34.00
CL 643	6.63	21.85	21.45
CL 648	5.40	11.00	20.70
CL 650	3.80	9.10	21.20
CL 651-0	6.50	12.50	21.11
CL 652	6.00	12.00	20.00
CL 653	4.50	19.00	16.95
CL 654	7.00	15.00	17.30
CL 655	3.55	15.25	16.10
CL 661	7.80	14.50	38.70
CL 665	3.25	12.70	26.20



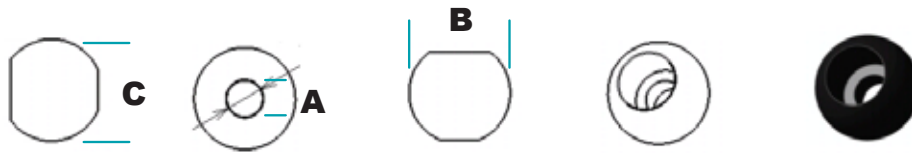

PART #	A	B	C
	METRIC	METRIC	METRIC
CLE 623	4.30	12.00	10.33
CLE 624	6.80	10.29	13.40
CLE 626	7.90	10.60	13.20
CLE 627	4.80	12.00	18.70
CLE 628	5.80	10.30	15.60
CLE 629	5.70	16.00	16.00
CLE 631	4.20	24.00	18.00
CLE 632	5.20	32.20	5.00
CLE 633	5.50	30.00	4.50
CLE 644	5.00	27.80	11.00
CLE 645	5.00	38.20	10.37
CLE 646	8.60	13.00	24.57
CLE 649	5.50	13.20	44.50
CLE 657	4.40	9.20	6.50
CLE 658	5.60	11.52	13.35
CLE 659	4.50	13.50	12.00
CLE 660	4.40	8.80	12.01
CLE 667	4.20	11.42	20.00
CLE 668	2.60	5.00	16.00



Meade's holders attach to standard sized plastic beverage containers. Use with webbing and hardware to create a custom look; attaches to golf bags, backpacks, belt loops, and more.

BOTTLE HOLDER

MATERIAL • POLYACETAL

DESCRIPTION	PART #
Black Holder	PLSBTLHLDRB
Natural Holder	PLSBTLHLDRC



STAYPUT FASTENER SYSTEM

The Stayput fastener system works with a #1 spur or #2 plain grommet. This system requires no pressure to open or close the fastener; the weight of the fabric on the fastener locks the toggle. The studs are available in two styles and lengths to accommodate various applications and fabric thicknesses. Stayput products are manufactured from UV stabilized glass-filled nylon.

		White	Black
	DESCRIPTION	PART NUMBER	PART NUMBER
	Vertical		
	Single Stud	SPVSS34W	SPVSS34B
	Double Stud	SPVDS35W	SPVDS35B
	Horizontal		
	Single Stud	SPHSS37W	SPHSS37B
	Double Stud	SPHDS38W	SPHDS38B
	Curved		
	Base	SPCB76W	SPCB78B
	Canvas-to-Canvas		
	Single Stud, 2 pc.	SPCCSS39W	SPCCSS39B
Double Stud, 2 pc.	SPCCDS40W	SPCCDS40B	
Keder Track			
Slide, 2 pc.	SPKTS10W		

The Stayput shock cord clip is used to apply tension to the fabric to which it is attached. This clip can be installed in different thicknesses of fabric, has excellent corrosion resistance and is UV stabilized.

	SHOCK CORD CLIP		
		White	Black
	Shock Cord Clip, 3pc	SPSCC70W	SPSCC75B
	Attachment Knob	SPAK86W	SPAK87B
	Tent Wall Hook, 2pc	SPTWH50W	SPTWH50B

FOUR-PIECE PLASTIC TURN FASTENER

Meade's plastic four-piece turn fastener is ideal where a non-corrosive positive locking fastener is needed. It is suitable for light-duty application.

	TF 217	TF 218	
	4-PIECE SET		MATERIAL • NYLON
	DESCRIPTION		PART NUMBER
	Black - PLASTIC TURN FASTENER-SQUARE		TF 217
Black - PLASTIC TURN FASTENER-OVAL		TF 218	

PLASTIC GROMMET & WASHER

Meade's plastic grommets and washers provide a reinforced hole for light-duty needs. This product is available in custom colors, solidifying the best appearance for many applications. Our plastic grommets and washers are offer defense in corrosion resistance.

SIZE	I.D.	O.D.	PART NUMBER	WHITE	BLACK
DESCRIPTION				PART NUMBER	
#2	13/32	27/32		GRMWSH250WPL	GRMWSH250BKPL
#3	15/32	15/16	GRMWSH280WPL	GRMWSH280BKPL	



SIZE	I.D.	O.D.	PART NUMBER	BLACK
DESCRIPTION				PART NUMBER
#2	23/64	1-3/16		GRMWSH250BKPLS



PLASTIC SNAP FASTENERS

Meade's plastic snap fasteners offer the maximum in corrosion resistance. Manufactured from the highest quality raw materials, Meade's plastic snap fasteners are highly durable, lightweight, and will accommodate material of varying thickness.

LIGHT-DUTY

DESCRIPTION	PART NUMBER	WHITE	BLACK
LIGNE 17 CAP		P3AWHT	P3ABLK
SOCKET		P3BWHT	P3BBLK
STUD		P3CWHT	P3CBLK

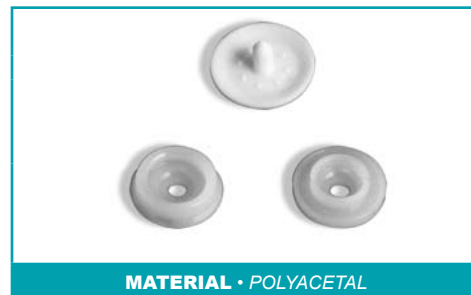

MEDIUM DUTY

DESCRIPTION	PART NUMBER	WHITE	BLACK
LIGNE 20 CAP		P6A20WHT	P6A20BLK
LIGNE 24 CAP		P6A24WHT	P6A24BLK
SOCKET		P6BWHT	P6BBLK
STUD	P6CWHT	P6CBLK	















HEAVY DUTY

DESCRIPTION	PART NUMBER	WHITE	BLACK
LIGNE 24 CAP		P7A24WHT	P7A24BLK
SOCKET		P7BWHT	P7BBLK
STUD		P7CWHT	P7CBLK





PANEL FASTENERS

Our panel fasteners are used for attaching material of various composition and thickness are found in electronic products, furniture, automotive door panels, seating and trim.

HOLE DIA.	SIZE LENGTH INCHES	PART #	DESCRIPTION	
.281	1 1/4"	CLIPXMAS2	9/16" SINGLE HEAD	
			COLOR NATURAL	
.281	1 5/16"	CLIPXMAS2A	3/4" SINGLE HEAD	
			COLOR NATURAL	
.281	1 9/16"	CLIPXMAS2ACL	3/4" SINGLE HEAD	
			COLOR NATURAL	
.281	1 5/16"	CLIPXMAS2B	11/16" SINGLE HEAD FULL GRIP	
			COLOR BLACK	
.281	1 7/16"	CLIPXMAS2C	3/4" SINGLE HEAD 7/8" GRIP	
			COLOR BLACK	
.281	3/4"	CLIPXMAS5	3/4" DOUBLE HEAD QUICK CONNECT	
			COLOR NATURAL	
.281	7/8"	CLIPXMAS6-T	3/4" SINGLE HEAD	
			COLOR BLACK	
.281	7/8"	CLIPXMAS6N	3/4" SINGLE HEAD	
			COLOR NATURAL	
.281	7/8"	CLIPXMAS6W-T	3/4" SINGLE HEAD	
			COLOR NATURAL	
.281 .328	1/2" X 7/8"	CLIPXMAS7	3/4" DOUBLE END CLIP W/ INNER STOP	
			COLOR WHITE	
.281	3/4"	CLIPXMAS8	3/4" DOUBLE HEAD FORD VEHICLES	
			COLOR WHITE	
.281	1 9/16"	CLIPXMAS9	1" SINGLE HEAD	
			COLOR	

Panel fasteners are used for attaching material of various composition and thickness are found in electrical products, furniture, automotive door panels, seating and trim. Please call Meade for special requirements as our line of panel fasteners is extensive.

PANEL FASTENERS

HOLE DIA.	SIZE LENGTH INCHES	PART #	DESCRIPTION	
.281	1 1/8"	CLIPXMAS10	7/8" SINGLE HEAD	
			COLOR	
			BLACK	
.281	3/4"	CLIPXMAS11	3/4" TRIPLE HEAD GM VEHICLES	
			COLOR	
			WHITE	
.3125	3/4"	CLIPXMAS12	1/2" DOUBLE HEAD FORD CLIP	
			COLOR	
			BLACK	
.281	13/16"	CLIPXMAS13	3/4" DOUBLE HEAD	
			COLOR	
			WHITE	
.265	1"	CLIPXMAS15	5/8" TRIPLE HEAD 3/8" GRIP	
			COLOR	
			WHITE	
.187	15/16"	CLIPXMAS16	1/2" SINGLE HEAD	
			COLOR	
			BLACK	
.187	15/16"	CLIPXMAS16W	1/2" SINGLE HEAD	
			COLOR	
			WHITE	
.385	1 1/16"	CLIPXMAS17	7/8" SINGLE HEAD	
			COLOR	
			BLACK	
.281	2"	CLIPXMAS19	5/8" SINGLE HEAD 7/8" GRIP	
			COLOR	
			WHITE	
.187	1/2"	CLIPXMAS28	1/2" SINGLE HEAD	
			COLOR	
			BLACK	
.187	1/2"	CLIPXMAS29	3/4" SINGLE HEAD	
			COLOR	
			BLACK	
.281	1 3/4"	CLIPXMAS31	1/2" SINGLE HEAD	
			COLOR	
			BLACK	

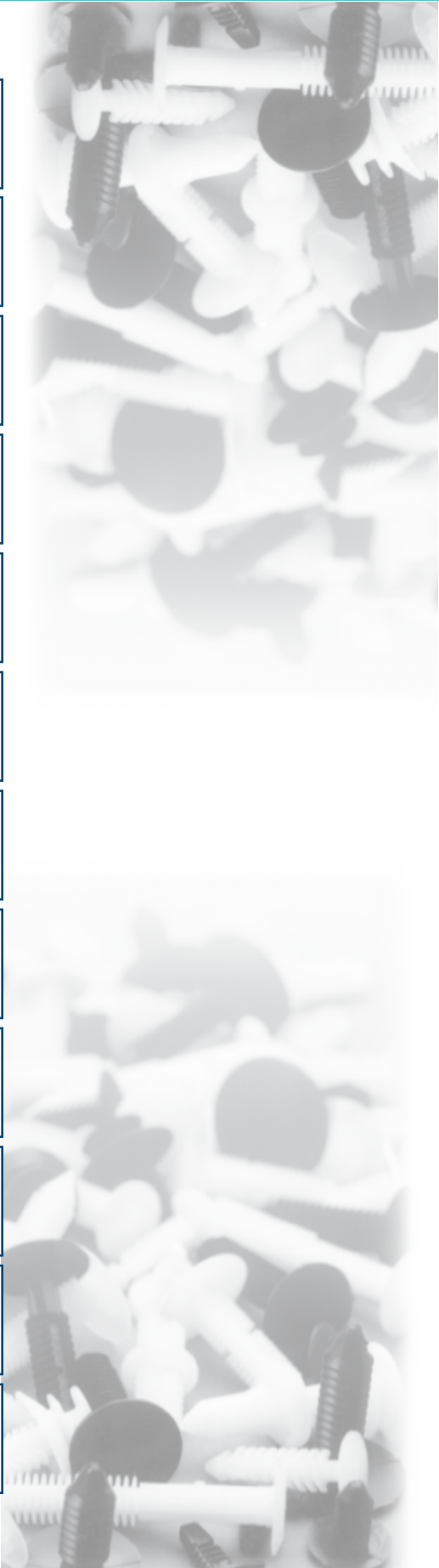

PANEL FASTENERS

HOLE DIA.	SIZE LENGTH	PART #	DESCRIPTION
.240	1 3/4"	CLIPRIV34	3/4" DRIVE RIVET
			COLOR
			WHITE
.281	.144"	CLIPXMAS44	LONG WEATHERSTRIP CLIP, NARROW HEAD
			COLOR
			BLACK
.281	1 3/16"	CLIPXMAS60	3/4" SINGLE HEAD GRIP
			COLOR
			BLACK
.281	1 1/8"	CLIPXMAS671A	1/2" DOUBLE HEAD
			COLOR
			BLACK
.281	.500-".812	RR120308	RATCHET RIVET
			COLOR

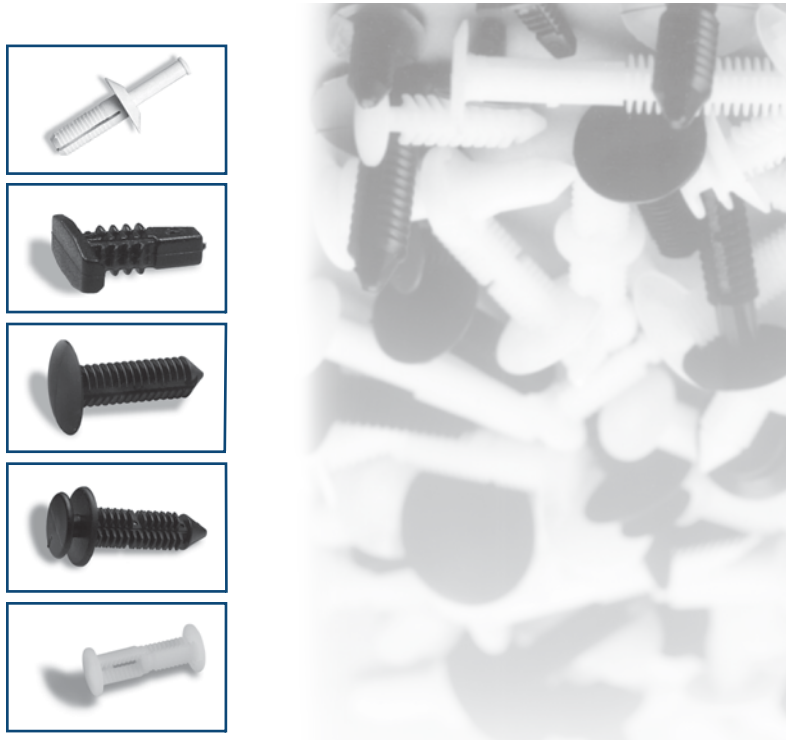

HOOK AND LOOP

FasGrip® brand sew-in hook and loop is made from nylon and recommended for applications requiring high shear strength and high cycle life. Exceeds minimum requirements for Class 1, Type 1 as per A-A-55126A (MIL-F-1840G).

			50 YD. REEL		SEW-IN HOOK & LOOP			
SIZE	REELS PER CARTON	CARTON YARDAGE	WHITE HOOK	WHITE LOOP	BLACK HOOK		BLACK LOOP	
			PART NUMBER	PART NUMBER	PART NUMBER	PART NUMBER	PART NUMBER	PART NUMBER
5/8"	30	1500	FG58WH	FG58WLN	FG58BH		FG58BLN	
3/4"	25	1250	FG34WH	FG34WLN	FG34BH		FG34BLN	
1"	20	1000	FG1WH	FG1WLN	FG1BH		FG1BLN	
1-1/2"	14	700	FG112WH	FG112WLN	FG112BH		FG112BLN	
2"	10	500	FG2WH	FG2WLN	FG2BH		FG2BLN	
4"	5	250	FG4WH	FG4WLN	FG4BH		FG4BLN	

SIZE	REELS PER CARTON	CARTON YARDAGE	BULK SPOOLS		SEW-IN HOOK & LOOP			
			WHITE HOOK	WHITE LOOP	BLACK HOOK		BLACK LOOP	
DESCRIPTION			PART NUMBER	PART NUMBER	PART NUMBER	PART NUMBER	PART NUMBER	PART NUMBER
5/8"	1	850	FGS58WH	FGS58WLN	FGS58BH		FGS58BLN	
1"	1	500	FGS1WH	FGS1WLN	FGS1BH		FGS1BLN	
1-1/2"	1	600	FGS112WH	FGS112WLN	FGS112BH		FGS112BLN	
2"	1	250	FGS2WH	FGS2WLN	FGS2BH		FGS2BLN	

SAMPLE <i>Please note that all colors may vary slightly from swatch samples shown.</i>	COLORS	50 YD. REEL		COLOR SEW-IN HOOK & LOOP							
		REELS PER CARTON	CARTON YARDAGE	REELS PER CARTON	CARTON YARDAGE	REELS PER CARTON	CARTON YARDAGE	REELS PER CARTON	CARTON YARDAGE	REELS PER CARTON	CARTON YARDAGE
		30	1500	25	1250	20	1000	14	700	10	500
		5/8"		3/4"		1"		1-1/2"		2"	
MATERIAL • POLYPROPYLENE		PART NUMBER	PART NUMBER	PART NUMBER	PART NUMBER	PART NUMBER	PART NUMBER	PART NUMBER	PART NUMBER	PART NUMBER	
	DARK GRAY HOOK	FG58DGH	FG34DGH	FG1DGH					FG2DGH		
	DARK GRAY LOOP	FG58DGLN	FG34DGLN	FG1DGLN					FG2DGLN		
	LIGHT GRAY HOOK	FG58LGH		FG1LGH					FG2LGH		
	LIGHT GRAY LOOP	FG58LGLN		FG1LGLN					FG2LGLN		
	NAVY HOOK	FG58NVH		FG1NVH					FG2NVH		
	NAVY LOOP	FG58NVLN		FG1NVLN					FG2NVLN		
	BEIGE HOOK	FG58BGH		FG1BGH					FG2BGH		
	BEIGE LOOP	FG58BGLN		FG1BGLN					FG2BGLN		
	YELLOW HOOK	FG58YLOH		FG1YLOH					FG2YLOH		
	YELLOW LOOP	FG58YLOLN		FG1YLOLN					FG2YLOLN		
	BLOOD RED HOOK	FG58BLRH		FG1BLRH					FG2BLRH		
	BLOOD RED LOOP	FG58BLRLN		FG1BLRLN					FG2BLRLN		
	MILITARY GREEN HOOK	FG58MGH		FG1MGH	FG112MGH				FG2MGH		
	MILITARY GREEN LOOP	FG58MGLN		FG1MGLN	FG112MGLN				FG2MGLN		
	ROYAL BLUE HOOK	FG58RBH		FG1RBH					FG2RBH		
	ROYAL BLUE LOOP	FG58RBLN		FG1RBLN					FG2RBLN		
	COFFEE BROWN HOOK	FG58CBH		FG1CBH					FG2CBH		
	COFFEE BROWN LOOP	FG58CBLN		FG1CBLN					FG2CBLN		

HOOK AND LOOP

FasGrip® brand rubber based pressure sensitive hook and loop is best suited for applications requiring high immediate tack and shear strength, moderate temperature conditions and bond strength.

			RUBBER BASED PRESSURE SENSITIVE HOOK & LOOP					
			WHITE HOOK		WHITE LOOP		BLACK HOOK	BLACK LOOP
SIZE	REELS PER CARTON	CARTON YARDAGE	PART NUMBER	PART NUMBER	PART NUMBER	PART NUMBER	PART NUMBER	
5/8"	24	1200	FG58WH	FG58WLN	FG58BH	FG58BLN		
1"	16	800	FG34WH	FG34WLN	FG34BH	FG34BLN		
1 1/2"	11	550	FG1WH	FGWLN	FG1BH	FG1BLN		
2"	9	450	FG112WH	FG112WLN	FG112BH	FG112BLN		

FasGrip® high temperature acrylic pressure sensitive hook and loop is used in high temperature applications where high bond strength is necessary.

			HIGH TEMPERATURE ACRYLIC PRESSURE SENSITIVE HOOK & LOOP					
			WHITE HOOK		WHITE LOOP		BLACK HOOK	BLACK LOOP
SIZE	REELS PER CARTON	CARTON YARDAGE	PART NUMBER	PART NUMBER	PART NUMBER	PART NUMBER	PART NUMBER	
5/8"	24	1200	FGAP58WH	FGAP58WLN	FGAP58BH	FGAP58BLN		
3/4"	20	1000	FGAP34WH	FGAP34WLN	FGAP34BH	FGAP34BLN		
1"	16	800	FGAP1WH	FGAP1WLN	FGAP1BH	FGAP1BLN		
1 1/2"	11	550	FGAP112WH	FGAP112WLN	FGAP112BH	FGAP112BLN		
2"	9	450	FGAP2WH	FGAP2WLN	FGAP2BH	FGAP2BLN		

FasGrip® fire-retardant hook and loop is suited for high temperature environments where flammability is a concern. This product is ideal for automotive and airline applications.

			FIRE-RETARDANT SEW-IN HOOK & LOOP					
			WHITE HOOK		WHITE LOOP		BLACK HOOK	BLACK LOOP
SIZE	REELS PER CARTON	CARTON YARDAGE	PART NUMBER	PART NUMBER	PART NUMBER	PART NUMBER	PART NUMBER	
5/8"	30	1500	FGFR58WH	FGFR58WLN	FGFR58BH	FGFR58BLN		
1"	20	1000	FGFR1WH	FGFR1WLN	FGFR1BH	FGFR1BLN		
2"	10	500	FGFR2WH	FGFR2WLN	FGFR2BH	FGFR2BLN		

FasGrip® polyester hook and loop is recommended for marine and underwater applications where increased resistance to chemicals and moisture is required.

			POLYESTER SEW-IN HOOK & LOOP					
			WHITE HOOK		WHITE LOOP		BLACK HOOK	BLACK LOOP
SIZE	REELS PER CARTON	CARTON YARDAGE	PART NUMBER	PART NUMBER	PART NUMBER	PART NUMBER	PART NUMBER	PART NUMBER
5/8"	30	1500	FGP58WH	FGP58WLN	FGP58BH	FGP58BLN		
1"	20	1000	FGP1WH	FGP1WLN	FGP1BH	FGP1BLN	FGP1LGH	FGP1LGLN
1 1/2"	14	700	FGP112WH	FGP112WLN	FGP112BH	FGP112BLN		
2"	10	500	FGP2WH	FGP2WLN	FGP2BH	FGP2BLN	FGP2LGH	FGP2LGLN

FasGrip® brand mushroom aggressive hook is recommended for applications requiring very high shear and peel strength with limited cycle life.

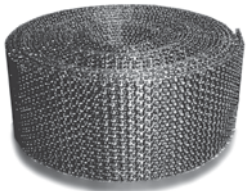
	SIZE	REELS PER CARTON	CARTON YARDAGE	MUSHROOM AGGRESSIVE SEW-IN HOOK			
				WHITE HOOK		BLACK HOOK	
		DESCRIPTION		PART NUMBER	PART NUMBER	PART NUMBER	PART NUMBER
	1"	20	1000	FGMSR1WH			
	2"	10	500			FGMSR2BH	
	4"	5	250	FGMSR4WH			
	SIZE	REELS PER CARTON	CARTON YARDAGE	MUSHROOM AGGRESSIVE PRESSURE SENSITIVE HOOK			
	DESCRIPTION						
1"	16	800			FGPMSR1BH		

FasGrip® hook and loop pressure sensitive kiss cut coins and squares are recommended for spot applications requiring moderate bonding strength.

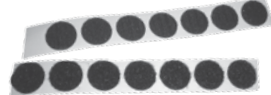
			KISS CUT COINS & SQUARES WITH PRESSURE SENSITIVE ADHESIVE			
SIZE	REELS PER CARTON	CARTON YARDAGE	WHITE HOOK	WHITE LOOP	BLACK HOOK	BLACK LOOP
	DESCRIPTION		PART NUMBER	PART NUMBER	PART NUMBER	PART NUMBER
5/8" (CIRCLE)	48	1250	FG KCPS-58-RWH	FG KCPS-58-WH	FG KCPS-58-RBH	FG KCPS-58-RBLN
7/8" (CIRCLE)	32	800	FG KCPS-78-RWH	FG KCPS-78-WLN	FG KCPS-78-RBH	FG KCPS-78-RBLN
7/8" (SQUARE)	32	800	FG KCPS-78-SBH	FG KCPS-78-SWLN	FG KCPS-78-SBH	FG KCPS-78-SBLN

FasGrip® hook and loop solo tape is a hook and loop wrap system, with hook on one side and loop on the other. Ideal for medical devices, appliance cords and much more.

	SIZE	REELS PER CARTON	CARTON YARDAGE	SOLO TAPE			
				BLACK HOOK			
		DESCRIPTION		PART NUMBER	PART NUMBER	PART NUMBER	PART NUMBER
	1"	20	1000	FG1SOLOB			
2"	20	1000	FG2SOLOB				

FasTape is a single component hook and loop fastener, with hook and loop on the same side. An easy-to-use alternative to conventional strapping systems and other applications.

	SIZE	REELS PER CARTON	CARTON YARDAGE	FASTAPE			
				BLACK HOOK & LOOP FASTAPE			
		DESCRIPTION		PART NUMBER	PART NUMBER	PART NUMBER	PART NUMBER
1"	20	1000	FGFM1B				

WEBBING

Color polypropylene webbing along with extensive plastic and metal hardware lines provides versatility for many applications.

SAMPLE <small>Please note that all colors may vary slightly from swatch samples shown.</small>	COLORS	LIGHTWEIGHT		
		1"	1-1/2"	2"
MATERIAL • POLYPROPYLENE		PART NUMBER	PART NUMBER	PART NUMBER
	COLUMBIAN BLUE	WEB PPL 25-COB	WEB PPL 38-COB	WEB PPL 51-COB
	NAVY	WEB PPL 25-NVY	WEB PPL 38-NVY	WEB PPL 51-NVY
	ROYAL	WEB PPL 25-RBL	WEB PPL 38-RBL	WEB PPL 51-RBL
	BROWN	WEB PPL 25-BRN	WEB PPL 38-BRN	WEB PPL 51-BRN
	BURGUNDY	WEB PPL 25-BUR	WEB PPL 38-BUR	WEB PPL 51-BUR
	CONCORD	WEB PPL 25-CRD	WEB PPL 38-CRD	WEB PPL 51-CRD
	ATHLETIC GOLD	WEB PPL 25-GLD	WEB PPL 38-GLD	WEB PPL 51-GLD
	CADET GRAY	WEB PPL 25-CGY	WEB PPL 38-CGY	WEB PPL 51-CGY
	CHARCOAL GRAY	WEB PPL 25-CHA	WEB PPL 38-CHA	WEB PPL 51-CHA
	LIGHT GRAY	WEB PPL 25-LGY	WEB PPL 38-LGY	WEB PPL 51-LGY
	FOREST GREEN	WEB PPL 25-FGR	WEB PPL 38-FGR	WEB PPL 51-FGR
	KELLY GREEN	WEB PPL 25-KGR	WEB PPL 38-KGR	WEB PPL 51-KGR
	TEAL GREEN	WEB PPL 25-TGN	WEB PPL 38-TGN	WEB PPL 51-TGN
	LINEN	WEB PPL 25-LIN	WEB PPL 38-LIN	WEB PPL 51-LIN
	NATURAL	WEB PPL 25-NAT	WEB PPL 38-NAT	WEB PPL 51-NAT
	ORANGE	WEB PPL 25-ORA	WEB PPL 38-ORA	WEB PPL 51-ORA
	RED	WEB PPL 25-RED	WEB PPL 38-RED	WEB PPL 51-RED
	SILVER	WEB PPL 25-SLV	WEB PPL 38-SLV	WEB PPL 51-SLV
	TAN	WEB PPL 25-TAN	WEB PPL 38-TAN	WEB PPL 51-TAN
	YELLOW	WEB PPL 25-YLO	WEB PPL 38-YLO	WEB PPL 51-YLO

SAMPLE	COLORS	LIGHTWEIGHT - 100 YD. ROLLS				POLYPROPYLENE	
		5/8"	3/4"	1"	1-1/2"	2"	3"
MATERIAL • POLYPROPYLENE		PART NUMBER	PART NUMBER	PART NUMBER	PART NUMBER	PART NUMBER	PART NUMBER
	WHITE	WEB PPL 16-WHT	WEB PPL 20-WHT	WEB PPL 25-WHT	WEB PPL 38-WHT	WEB PPL 51-WHT	WEB PPL 75-WHT
	BLACK	WEB PPL 16-BLK	WEB PPL 20-BLK	WEB PPL 25-BLK	WEB PPL 38-BLK	WEB PPL 51-BLK	

SAMPLE	COLORS	HEAVYWEIGHT - 100 YD. ROLLS					POLYPROPYLENE	
		1/2"	3/4"	1"	1-1/4"	1-1/2"	2"	3"
MATERIAL • POLYPROPYLENE		PART NUMBER	PART NUMBER	PART NUMBER	PART NUMBER	PART NUMBER	PART NUMBER	
	WHITE			WEB PPH 25-WHT	WEB PPH 32-WHT <small>(1000 yd. roll)</small>	WEB PPH 38-WHT	WEB PPH 51-WHT	
	BLACK	WEB PPH 13-BLK 50 <small>(Sold in 50 yd. rolls)</small>	WEB PPH 20-BLK	WEB PPH 25-BLK	WEB PPH 32-BLK <small>(1000 yd. roll)</small>	WEB PPH 38-BLK	WEB PPH 51-BLK	WEB PPH 75-BLK

SAMPLE	COLORS	LIGHTWEIGHT - 100 YD. ROLLS				NYLON	
		3/8"	7/16"	1"	1-1/2"	2"	
MATERIAL • NYLON		PART NUMBER	PART NUMBER	PART NUMBER	PART NUMBER	PART NUMBER	PART NUMBER
	WHITE	WEB NYS 7-RED <small>(Not available in white)</small>	WEB NYS 10-RED <small>(Not available in white)</small>	WEB NYS 25-WHT	WEB NYS 38-WHT	WEB NYS 51-WHT	
	BLACK	WEB NYS 7-BLK	WEB NYS 10-BLK	WEB NYS 25-BLK	WEB NYS 38-BLK	WEB NYS 51-BLK	

SAMPLE	COLORS	HEAVYWEIGHT - 100 YD. ROLLS			NYLON	
		1"		1-1/2"	2"	
MATERIAL • NYLON		PART NUMBER	PART NUMBER	PART NUMBER	PART NUMBER	PART NUMBER
	WHITE	WEB NYH 25-WHT		WEB NYH 38-WHT		WEB NYH 51-WHT
	BLACK	WEB NYH 25-BLK		WEB NYH 38-BLK		WEB NYH 51-BLK

SAMPLE	COLORS	LIGHTWEIGHT - 100 YD. ROLLS			POLYESTER	
		3/4"	1"	1-1/2"	2"	
MATERIAL • POLYESTER		PART NUMBER	PART NUMBER	PART NUMBER	PART NUMBER	PART NUMBER
	WHITE	WEB PEL 20-WHT	WEB PEL 25-WHT	WEB PEL 38-WHT	WEB PEL 51-WHT	
	BLACK	WEB PEL 20-BLK	WEB PEL 25-BLK	WEB PEL 38-BLK	WEB PEL 51-BLK	

SAMPLE	COLORS	HEAVYWEIGHT - 100 YD. ROLLS			POLYESTER	
		3/4"	1"	1-1/2"	2"	
MATERIAL • POLYESTER		PART NUMBER	PART NUMBER	PART NUMBER	PART NUMBER	PART NUMBER
	WHITE	WEB PEH 20-WHT	WEB PEH 25-WHT	WEB PEH 38-WHT	WEB PEH 51-WHT	
	BLACK	WEB PEH 20-BLK	WEB PEH 25-BLK	WEB PEH 38-BLK	WEB PEH 51-BLK	

SAMPLE	COLORS	SEAT-BELT - 100 YD. ROLLS		POLYESTER V-STYLE	
		1"		2"	
MATERIAL • POLYPROPYLENE		PART NUMBER	PART NUMBER	PART NUMBER	PART NUMBER
	WHITE	WEB PET 25V3 WHT <small>(3 Panel)</small>			
	BLACK	WEB PET 25V3 BLK <small>(3 Panel)</small>		WEB PET 51V4 BLK <small>(4 Panel)</small>	

Meade

Distributing

6823 West Warren Avenue
Detroit, Michigan 48210

Telephone

(313) 361-3200

FAX

(313) 361-9653

Electronic mail

General Information: info@MeadeDistributing.com

Sales: Sales@MeadeDistributing.com

Customer Support: Support@MeadeDistributing.com

0 100 200 300 400 500 600 MILES
0 100 200 300 400 500 600 KILOMETERS

Plastic Fasteners & Hardware